

# PBA439 / PBA439x / PBA439xx

**English** User Manual Weighing Platform

**Deutsch** Benutzerhandbuch Wägebrücke

**Français** Guide de l'utilisateur Plate-forme de pesage

**Español** Manual de usuario Plataformas de pesada

**Italiano** Manuale per l'utente Piattaforma di pesatura

**Nederlands** Handleiding Weegplatform

**Português** Manual do usuário Plataforma de pesagem

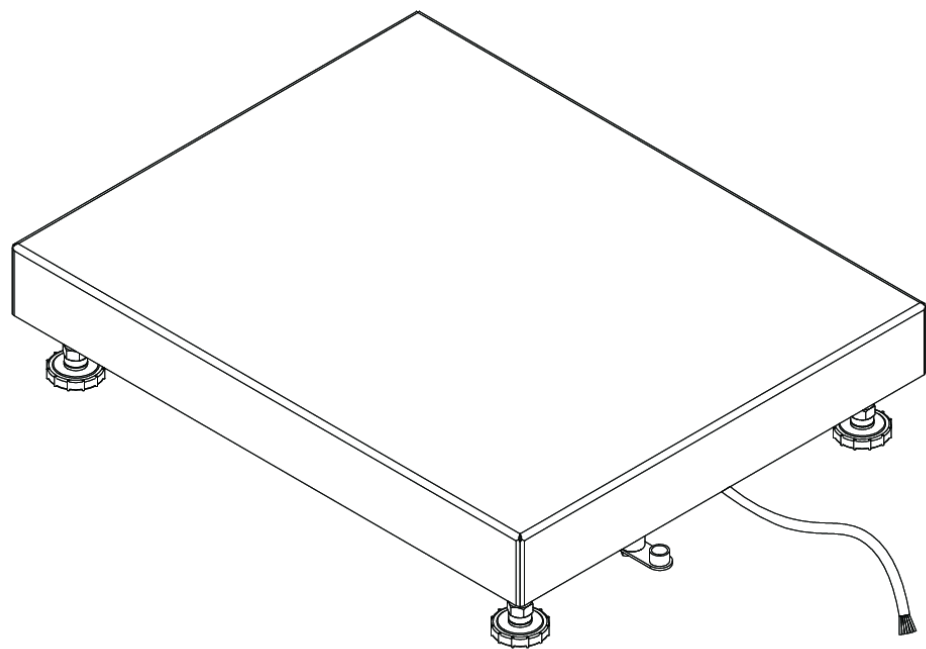

**METTLER TOLEDO**



---

User Manual

**English**

---

Benutzerhandbuch

**Deutsch**

---

Guide de l'utilisateur

**Français**

---

Manual de usuario

**Español**

---

Manuale per l'utente

**Italiano**

---

Handleiding

**Nederlands**

---

Manual do usuário

**Português**

---



# METTLER TOLEDO Service

Congratulations on choosing the quality and precision of METTLER TOLEDO. Proper use of your new equipment according to this Manual and regular calibration and maintenance by our factory-trained service team ensures dependable and accurate operation, protecting your investment. Contact us about a service agreement tailored to your needs and budget. Further information is available at ► [www.mt.com/service](http://www.mt.com/service).

There are several important ways to ensure you maximize the performance of your investment:

- 1 **Register your product:** We invite you to register your product at [www.mt.com/productregistration](http://www.mt.com/productregistration) so we can contact you about enhancements, updates and important notifications concerning your product.
- 2 **Contact METTLER TOLEDO for service:** The value of a measurement is proportional to its accuracy – an out of specification scale can diminish quality, reduce profits and increase liability. Timely service from METTLER TOLEDO will ensure accuracy and optimize uptime and equipment life.
  - ➔ **Installation, Configuration, Integration and Training:** Our service representatives are factory-trained weighing equipment experts. We make certain that your weighing equipment is ready for production in a cost effective and timely fashion and that personnel are trained for success.
  - ➔ **Initial Calibration Documentation:** The installation environment and application requirements are unique for every industrial scale so performance must be tested and certified. Our calibration services and certificates document accuracy to ensure production quality and provide a quality system record of performance.
  - ➔ **Periodic Calibration Maintenance:** A Calibration Service Agreement provides on-going confidence in your weighing process and documentation of compliance with requirements. We offer a variety of service plans that are scheduled to meet your needs and designed to fit your budget.



# Table of Contents

<b>1</b>	<b>Safety Instructions</b>	<b>3</b>
1.1	Intended use .....	3
1.2	Misuse .....	3
1.3	Safety Precautions .....	3
1.4	Specific Conditions of Use.....	3
<b>2</b>	<b>Introduction</b>	<b>4</b>
2.1	Assortment.....	4
2.2	About this Manual.....	4
2.3	Further Documents.....	4
<b>3</b>	<b>Installation and Operation</b>	<b>5</b>
3.1	Connecting the Weighing Platform to the Weighing Terminal.....	5
3.2	Leveling.....	6
3.3	Equipotential Bonding .....	6
3.4	Checking the Weighing Platform .....	6
3.5	Operating the Weighing Platform .....	7
3.6	Installation, Configuration, Service and Repair .....	7
<b>4</b>	<b>Maintenance</b>	<b>8</b>
4.1	Notes on Cleaning .....	8
4.2	Subsequent Treatment .....	8
4.3	Disposal .....	8
<b>5</b>	<b>Repair</b>	<b>9</b>
<b>6</b>	<b>Technical Data and Operating Limits</b>	<b>10</b>
6.1	Maximum Verification Scale Interval .....	10
6.2	Maximum Permissible Load.....	10
6.3	Technical Data of Load Cell.....	11
6.3.1	Ex Approval.....	11
6.3.2	Load Cell Compliance Standard .....	11
6.4	Dimensions.....	13
6.5	Information about Capacity Preload .....	14
6.5.1	Preload Table in Kilogram.....	15
6.5.2	Preload Table in Pound .....	16
6.6	Accessories.....	17
<b>7</b>	<b>Mounting Possibilities</b>	<b>19</b>
<b>8</b>	<b>Appendix</b>	<b>20</b>
8.1	Label.....	20
8.2	Control Drawing.....	21
8.3	Installation Drawing .....	22





# 1 Safety Instructions

## 1.1 Intended use

PBA439(x/xx) weighing platforms are part of a modular weighing system consisting of a METTLER TOLEDO weighing terminal as indicator and at least one weighing platform.

- Use the weighing platform only for weighing in accordance with this manual.
- The weighing platform is intended for indoor use only.
- Only the PBA439x/xx weighing platform is suitable for use in hazardous environment as specified below.
- Any other type of use is considered as not intended.

### Legal metrology

- For use in legal metrology, only use approved weighing platforms.
- When using in legal metrology, the operating company is responsible for observing all national weights & measurements requirements.
- Please contact the METTLER TOLEDO Service organization for questions related to the use in legal for trade applications.

## 1.2 Misuse

- Do not use the weighing terminal other than for weighing operations.
- Do not use the weighing platform in another environment than specified in the --- MISSING LINK ---.
- Do not modify the weighing platform.
- Do not use the weighing terminal beyond the limits of the technical specifications.
- Do not use the weighing platform for storing goods.
- Avoid falling goods on the weighing platform.

## 1.3 Safety Precautions

- Only personnel trained and qualified by METTLER TOLEDO may install and maintain the weighing platform.
- Be careful when transporting or lifting heavy devices.
- Always disconnect the weighing platform from the power source before installing, servicing, cleaning or performing maintenance.
- The connection cable may not be disconnected from the weighing terminal while energized.
- Make sure the weighing platform has reached room temperature before switching on the power supply.
- The explosion-protected weighing platforms PBA439x/xx are approved for operation in the following hazardous areas:
  - ATEX/IECEx Category 2, Category 3, gas/dust (Zone 1/21, Zone 2/22)
  - cFMus, Class I,II,III, Div. 1, Div. 2
- There is an increased risk of injury and damage when the weighing platforms are used in hazardous areas! Special care must be taken when working in such areas.
- In case of the PBA439x/xx weighing platform, only use cable glands that are suitable and approved for hazardous areas for inserting the weighing cell cable into the weighing terminal.
- Explosion-protected weighing platforms may only be used in hazardous areas in conjunction with weighing terminals with the appropriate approval and interface specification.

## 1.4 Specific Conditions of Use

- In an explosive atmosphere caused by air/dust moisture, the loose ends of the cable shall be connected outside the hazardous or in a suitable enclosure with a degree of protection of at least IP6X in accordance with IEC/EN 60529.

## 2 Introduction

### 2.1 Assortment

This manual focuses on the product series PBA439(x/xx).

The PBA439(x/xx) series offer a variety of weighing platforms to fit your requirements. It is approvable and offers various sizes and capacities

Type	Load Plate Material	Scale Frame Material	Load Cell Design	Environment IP Protection	Hazardous Approval
PBA439	Stainless steel AISI304	Stainless steel AISI304	Stainless steel, hermetically sealed	Dry, wet, IP68/IP69K	-
PBA439x					Zone 1/21, Div 1
PBA439xx					Zone 2/22, Div 2

### 2.2 About this Manual



This manual contains all information for the operator of the product.

- Read this manual carefully before use.
- Keep this manual for future reference.
- Pass this manual to any future owner or user of the product.

### 2.3 Further Documents

In addition to this manual you can download the following documents from ► [www.mt.com](http://www.mt.com):

- Brochure
- Installation information (for trained personnel under the control of the operating company)
- Type approval documents

#### Certificate Download

US, Canada, ATEX, UKEX and IECEx certificates can be downloaded from  
► <https://www.mt.com/us/en/home/search/compliance.html/compliance/>.

## 3 Installation and Operation

### 3.1 Connecting the Weighing Platform to the Weighing Terminal

The PBA439(x/xx) weighing platforms are designed for use with analog METTLER TOLEDO weighing terminals.

- 1 Insert the weighing platform cable through the cable gland into the weighing terminal.
- 2 Connect the weighing platform cable to the terminal strip of the weighing terminal according to the following table.

Signal	Wire Color	Connector
SIG+	White	
SIG-	Red	
EXC+	Green	
EXC-	Black	
SEN+	Yellow	
SEN-	Blue	



#### **WARNING**

The cable shield must be grounded.

#### Safety Precautions for Connections

- When connecting the weighing platform in hazardous area, strictly follow the requirements as stated in control drawing available in [Appendix ▶ Page 20].
- Please check the special conditions for safe use in the drawings and the certificates in [Appendix ▶ Page 20].
- The cable shield is connected to the load cell spring element (the body of the load cell). Please consider the appropriate connection between load cell and terminal (or junction box) based on the installation scenario.
- The resistance between all safety ground connections and the system grounding electrode must not exceed 1 ohm.
- Installation shall be in accordance with relevant electrical installation standards.
- Not following these instructions will jeopardize the explosion safety.

## 3.2 Leveling

Only a weighing platform which is aligned exactly horizontally supplies exact weighing results. The weighing platform has to be leveled during the initial installation and whenever its location is changed.

- 1 Turn the adjustable feet of the weighing platform until the air bubble of the spirit level is positioned in the inner circle.
- 2 Tighten the lock nuts of the adjustable feet.

👉 Scan the QR code to watch the video

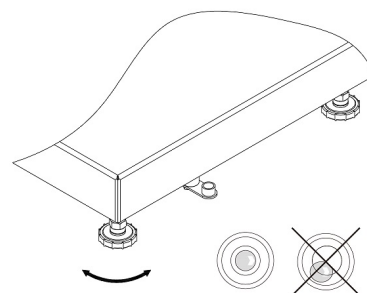

## 3.3 Equipotential Bonding

The equipotential bonding for the PBA439x/xx weighing platforms is mounted in the factory. The wiring must be installed by a professional electrician on customer site. METTLER TOLEDO Service only has a monitoring and consulting function here. Connect the equipotential bonding (PA) of all devices (weighing platform and weighing terminal) in accordance with the country-specific regulations and standards. In the process, make sure that all device housings are connected to the same potential via the PA terminal.

### Note

The equipment is protected against electric shock acc. IEC60950, class II.

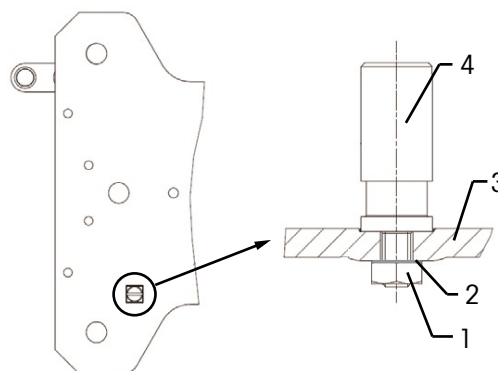

- 1 - Hexagonal lock nut, M4 KEPS
- 2 - Washer
- 3 - Base Frame
- 4 - Equipotential bonding terminal, torque 3.5 Nm

Order number of the equipotential bonding kit 72237321

## 3.4 Checking the Weighing Platform

### Function Check

- 1 Make sure that the weighing platform is connected to a weighing terminal and that the weighing terminal is switched on.
- 2 Make sure that the weighing platform is unloaded and the display of the weighing terminal shows 0.
- 3 Load the weighing platform. The weighing terminal must show a value different from 0.
- 4 Unload the weighing platform. The weighing terminal must return to 0.

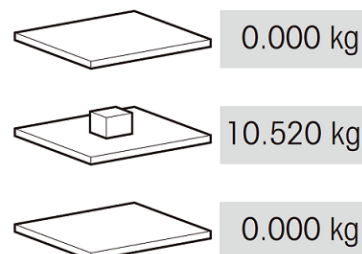

### Verification Test

For a verification test refer to the user manual of the connected weighing terminal. If the verification seal is broken, verification is no longer valid.

### 3.5 Operating the Weighing Platform

For best weighing results, observe the following:

- Ensure the load plate is correctly placed.

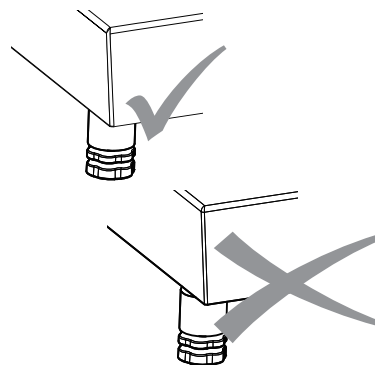

- To achieve best weighing results place the weighing sample always on the same position on the weighing platform.

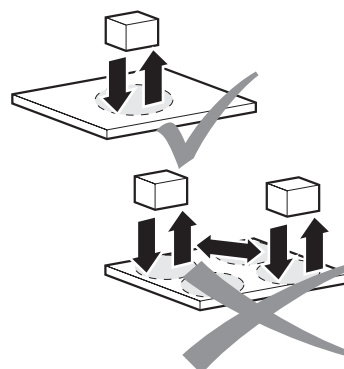

- Avoid abrasive and wear processes.

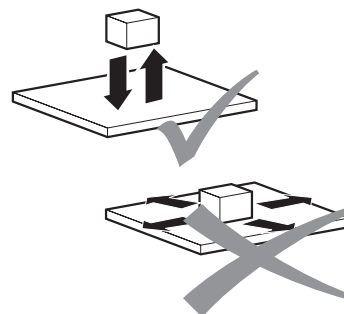

- Avoid falling loads, shocks and lateral impacts.

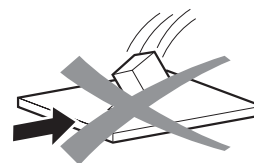

### 3.6 Installation, Configuration, Service and Repair

For installation, configuration, service and repair of the weighing platforms call the METTLER TOLEDO Service.

## 4 Maintenance

### 4.1 Notes on Cleaning

---

#### Note

##### Damage to the weighing platform due to incorrect use of cleaning agents.

- Only use disinfectants and cleaning agents in accordance with their manufacturer's instructions.
  - Do not use highly acidic, highly alkaline or highly chlorinated cleaning agents. Avoid substances with a high or low pH value since increased danger of corrosion otherwise exists.
  - Be particularly careful when cleaning the load cell.
- 

#### Cleaning Procedure

- Remove dirt and deposits at regular intervals from the outside and inside of the weighing platform.
  - ➔ The procedure depends both on the type of surface and on the environmental conditions prevailing at the installation location.

#### Cleaning in a wet environment (stainless steel versions)

- Use a water jet up to 80 °C / 176 °F and max. 80 bars, minimum distance 40 cm / 16".
- Use household cleaning agents.

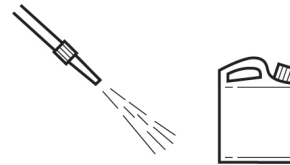

#### Cleaning in a corrosive environment (stainless steel versions)

- Use a water jet.
  - Inner cleaning**, load cell, load plate opened: up to 60 °C / 140 °F and max. 2 bars, minimum distance 40 cm / 16".
  - Outer cleaning**, load plate closed: to 80 °C / 176 °F and max. 80 bars, minimum distance 40 cm / 16".
- Remove corrosive substances at regular intervals.
- Only use disinfectants and cleaning agents in accordance with their manufacturer's specifications and instructions

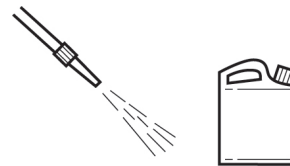

### 4.2 Subsequent Treatment

In order to protect the scale, carry out the following subsequent treatment:

- Rinse the scale with clear water and remove cleaning agent completely.
- Dry off the scale with a lint-free cloth.
- With stainless steel scales, treat the inside and outside with an oil suitable for foodstuffs.

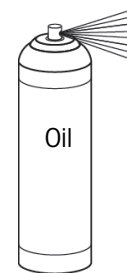

### 4.3 Disposal

In conformance with the European Directive 2012/19/EU on Waste Electrical and Electronic Equipment (WEEE) this device may not be disposed of in domestic waste. This also applies to countries outside the EU, per their specific requirements.

Please dispose of this product in accordance with local regulations at the collecting point specified for electrical and electronic equipment. If you have any questions, please contact the responsible authority or the distributor from which you purchased this device. Should this device be passed on to other parties, the content of this regulation must also be related.



## 5 Repair

This equipment is certified for use in hazardous locations, therefore no modifications are allowed. Repairs must only be performed by personnel specifically trained for repairs of this equipment.

## 6 Technical Data and Operating Limits

### 6.1 Maximum Verification Scale Interval

Max. verification scale interval [e] / OIML	Capacity							
	3 kg	6 kg	15 kg	30 kg	60 kg	150 kg	300 kg	600 kg
1 x 3000e Max / e [kg]	3 / 0.001	6 / 0.002	15 / 0.005	30 / 0.01	60 / 0.02	150 / 0.05	300 / 0.1	600 / 0.2

Max. verification scale interval [d] / NTEP	Capacity							
	-	10 lb	25 lb	50 lb	100 lb	250 lb	500 lb	1000 lb
1 x 5000d Max / d [lb]	-	10 / 0.002	25 / 0.005	50 / 0.01	100 / 0.02	250 / 0.05	500 / 0.1	1000 / 0.2

### 6.2 Maximum Permissible Load

All weighing platforms are equipped with an overload protection. With the robust scale design you can occasionally exceed the rated capacity of the platform without damage. The maximum static safe load must never be exceeded.

- Observe the following operation limits.

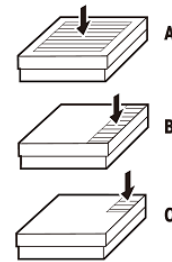

Model	A - Central Load	B - Side Load	C - Corner Load
PBA439(x/xx)-QA	40 kg / 80 lb	30 kg / 60 lb	15 kg / 30 lb
PBA439(x/xx)-A	40 kg / 80 lb	30 kg / 60 lb	15 kg / 30 lb
PBA439(x/xx)-QB	100 kg / 200 lb	70 kg / 140 lb	35 kg / 70 lb
PBA439(x/xx)-BB	100 kg / 200 lb	70 kg / 140 lb	35 kg / 70 lb
PBA439(x/xx)-B	200 kg / 400 lb	140 kg / 280 lb	75 kg / 150 lb
PBA439(x/xx)-BC	400 kg / 800 lb	300 kg / 600 lb	150 kg / 300 lb
PBA439(x/xx)-CC	700 kg / 1400 lb	400 kg / 800 lb	200 kg / 400 lb



#### **WARNING**

**Avoid falling loads, shock loads as well as impacts from the side.**



### 6.3 Technical Data of Load Cell

Rated Output	mV/V	1.8 ± 0.2
Input Resistance	Ω	384 ± 15
Output Resistance	Ω	350 ± 4
Recommended Voltage	V (DC / AC)	5 - 15
Max. Excited Voltage	V (DC / AC)	20
Cable Sheath	-	PVC
IP Rating	-	IP68/IP69K

#### 6.3.1 Ex Approval

This section covers only the Ex-relevant aspects of the product.

The Load Cell SLP84x(x=6,7,8) has been granted with:

ATEX Certificate	FM21ATEX0003X, FM21ATEX0025X
UK Certificate	FM21UKEX0079X, FM21UKEX0080X
IECEX Certificate	IECEX FMG21.0003X
US Certificate	FM21US0005X
Canadian Certificate	FM21CA0002X

The certificates listed above and the related installation drawings please refer to [Appendix ▶ Page 20].

#### 6.3.2 Load Cell Compliance Standard

##### US Standards

Title	Number	Issue Date
Electrical Equipment for Use in Hazardous (Classified) Locations – General Requirements	FM Class 3600	2018
Intrinsically Safe Apparatus and Associated Apparatus for Use in Class I, II, and III, Division 1, Hazardous (Classified) Locations	FM Class 3610	2021
Nonincendive Electrical Equipment for Use in Class I and II, Division 2, and Class III, Divisions 1 and 2, Hazardous (Classified) Locations	FM Class 3611	2021
Electrical Equipment for Measurement, Control and Laboratory Use	FM Class 3810	2021
Explosive atmospheres - Part 0: Equipment - General requirements	ANSI/UL 60079-0	2019
Explosive atmospheres – Part 11: Equipment protection by intrinsic safety "i"	ANSI/ISA 60079-11	2014
Nonincendive electrical equipment for use in Class I and II, Division 2 and Class III, Divisions 1 and 2 hazardous (classified) locations	ANSI/UL 121201	2017
Safety Requirements for Electrical Equipment for Measurement, Control, and Laboratory Use – Part 1: General Requirements	ANSI/UL 61010-1	2012
Degrees of Protection Provided by Enclosures (IP Code)	ANSI/IEC 60529	2020

##### Canadian Standards

Title	Number	Issue Date
Non-Incendive Electrical Equipment for use in Class I, Division 2 Hazardous Locations	CSA C22.2 No. 213	2017
Explosive atmospheres - Part 0: Equipment - General requirements	CAN/CSA-C22.2 No. 60079-0	2019
Explosive atmospheres - Part 11: Equipment protection by intrinsic safety "i"	CAN/CSA-C22.2 No. 60079-11	2014
Explosive atmospheres - Part 7: Equipment protection by increased safety "e"	CAN/CSA-C22.2 No. 60079-7	2018
Explosive atmospheres - Part 31: Equipment dust ignition protection by enclosure "t"	CAN/CSA-C22.2 No. 60079-31	2015

Title	Number	Issue Date
Safety Requirements for Electrical Equipment for Measurement, Control, and Laboratory Use – Part 1: General Requirements	CSA C22.2 No. 61010-1	2012
Degrees of Protection Provided by Enclosures (IP Code)	CSA C22.2 No. 60529	2016

### IECEx Standards

Title	Number	Issue Date
Explosive atmospheres - Part 0: Equipment - General requirements	IEC 60079-0	2017
Explosive atmospheres - Part 11: Equipment protection by intrinsic safety "i"	IEC 60079-11	2011
Explosive atmospheres - Part 7: Equipment protection by increased safety "e"	IEC 60079-7	2017
Explosive atmospheres - Part 31: Equipment dust ignition protection by enclosure "t"	IEC 60079-31	2013
Degrees of Protection Provided by Enclosures (IP Code)	IEC 60529	2013

### ATEX Standards

Title	Number	Issue Date
Explosive atmospheres - Part 0: Equipment - General requirements	EN IEC 60079-0	2018
Explosive atmospheres - Part 11: Equipment protection by intrinsic safety "i"	EN 60079-11	2012
Explosive atmospheres - Part 7: Equipment protection by increased safety "e"	EN 60079-7	2015 +A1:2018
Explosive atmospheres - Part 31: Equipment dust ignition protection by enclosure "t"	EN 60079-31	2014
Degrees of Protection Provided by Enclosures (IP Code)	EN 60529	1991 + A1:2000 + A2:2013

### UKEX Standards

Title	Number	Issue Date
Explosive atmospheres - Part 0: Equipment - General requirements	EN IEC 60079-0	2018
Explosive atmospheres - Part 11: Equipment protection by intrinsic safety "i"	EN 60079-11	2012
Explosive atmospheres - Part 7: Equipment protection by increased safety "e"	EN 60079-7	2015 +A1:2018
Explosive atmospheres - Part 31: Equipment dust ignition protection by enclosure "t"	EN 60079-31	2014
Degrees of Protection Provided by Enclosures (IP Code)	EN 60529	1991 + A1:2000 + A2:2013

## 6.4 Dimensions

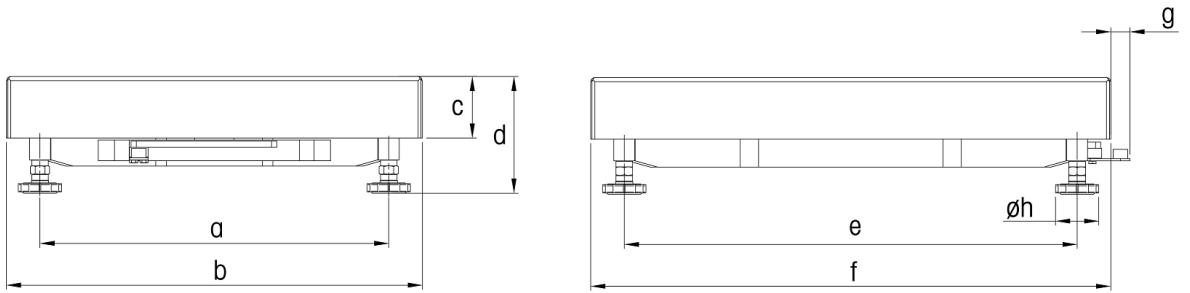

Dimensions		a	b	c	d *	e	f	g	h
PBA439(x/xx)-QA	mm	163	228	56	85.6	163	228	21	42
	inch	6.42	8.98	2.20	3.37	6.42	8.98	0.83	1.65
PBA439(x/xx)-A	mm	175	240	56	85.6	235	300	21	42
	inch	6.89	9.45	2.20	3.37	9.25	11.81	0.83	1.65
PBA439(x/xx)-QB	mm	240	305	57	96.6	253	305	18	42
	inch	9.45	12.01	2.24	3.8	9.96	12.01	0.71	1.65
PBA439(x/xx)-BB	mm	235	300	57	96.6	335	400	18	42
	inch	9.25	11.81	2.24	3.8	13.19	15.75	0.71	1.65
PBA439(x/xx)-B	mm	335	400	59	100.1	435	500	18	42
	inch	13.19	15.75	2.32	3.94	17.13	19.69	0.71	1.65
PBA439(x/xx)-BC	mm	437	500	73	106.8	584	650	17	42
	inch	17.20	19.69	2.87	4.2	22.99	25.59	0.67	1.65
PBA439(x/xx)-CC	mm	503	600	85	128.3	724	800	18	42
	inch	19.80	23.62	3.35	5.05	28.5	31.50	0.71	1.65

\* : 1) d = minimum platform height. With the adjustable scale feet, the platform height can increase by 10 mm / 0.39 inch at maximum.

2) With the hygienic kit option, the minimum platform height (d) increases by 12 mm / 0.47 inch.

## 6.5 Information about Capacity Preload

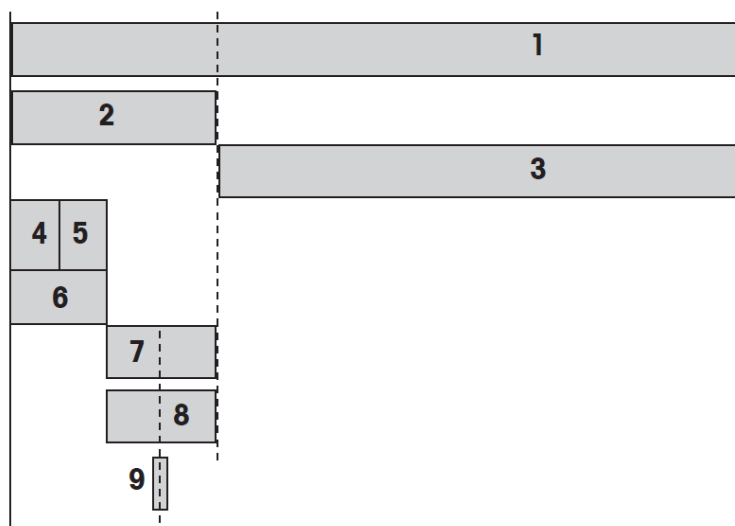

<b>1</b>	Maximum load range of the load cell ( $E_{max}$ )
<b>2</b>	Maximum preload = Maximum load range <b>1</b> – Maximum load <b>3</b>
<b>3</b>	Maximum load = Maximum load range <b>1</b> – Maximum preload <b>2</b>
<b>4</b>	Preload top section
<b>5</b>	Preload weighing pan
<b>6</b>	Preload ex works = Preload top section <b>4</b> + Preload weighing pan <b>5</b>
<b>7</b>	Mechanical preload reserve = Maximum preload <b>2</b> – Preload ex works <b>6</b>
<b>8</b>	The zero-set range (switching on) can be set. The zero-set range must lie within the maximum preload. The zero-set range may amount to a max. of 18 % of the maximum load.
<b>9</b>	Zero-set range $\pm 2$ % of the maximum load

### 6.5.1 Preload Table in Kilogram

Type	Dimensions [mm]	Max. load (3)	Preload top section (4)	Preload weighing pan (5)	Preload ex works (6)	Mech. preload reserve (7)	Zero set range (8)	Max. load range (1)
PBA439(x/xx)-QA3	228x228	3	1.04	0.95	1.99	6.01	0.54	11
PBA439(x/xx)-QA6	228x228	6	1.04	0.95	1.99	3.01	1.08	11
PBA439(x/xx)-A3	240x300	3	1.49	1.23	2.72	5.28	0.54	11
PBA439(x/xx)-A6	240x300	6	1.49	1.23	2.72	2.28	1.08	11
PBA439(x/xx)-A15	240x300	15	1.49	1.23	2.72	4.28	2.70	22
PBA439(x/xx)-QB15	305x305	15	1.70	1.51	3.21	3.79	2.70	22
PBA439(x/xx)-QB30	305x305	30	1.70	1.51	3.21	16.79	5.40	50
PBA439(x/xx)-QB60	305x305	60	1.70	1.51	3.21	36.79	10.80	100
PBA439(x/xx)-BB30	300x400	30	2.08	1.86	3.94	16.06	5.40	50
PBA439(x/xx)-BB60	300x400	60	2.08	1.86	3.94	36.06	10.80	100
PBA439(x/xx)-B30	400x500	30	3.45	2.85	6.30	13.70	5.40	50
PBA439(x/xx)-B60	400x500	60	3.45	2.85	6.30	33.70	10.80	100
PBA439(x/xx)-B150	400x500	150	3.45	2.85	6.30	43.70	27.00	200
PBA439(x/xx)-BC60	500x650	60	7.00	5.80	12.80	27.20	10.80	100
PBA439(x/xx)-BC150	500x650	150	7.00	5.80	12.80	35.00	27.00	250
PBA439(x/xx)-BC300	500x650	300	7.00	5.80	12.80	187.20	54.00	500
PBA439(x/xx)-CC60	600x800	60	9.36	11.00	20.36	19.64	10.80	100
PBA439(x/xx)-CC150	600x800	150	9.36	11.00	20.36	79.64	27.00	250
PBA439(x/xx)-CC300	600x800	300	9.36	11.00	20.36	179.64	54.00	500
PBA439(x/xx)-CC600	600x800	600	11.50	14.10	25.60	124.40	108.00	750

## 6.5.2 Preload Table in Pound

Type	Dimensions [inch]	Max. load (3)	Preload top section (4)	Preload weighing pan (5)	Preload ex works (6)	Mech. preload reserve (7)	Zero set range (8)	Max. load range (1)
PBA439(x/xx)-QA6	9x9	10	2.29	2.09	4.39	9.86	1.8	24
PBA439(x/xx)-A6	9.5x11.8	10	3.28	2.71	6.00	8.25	1.8	24
PBA439(x/xx)-A15	9.5x11.8	25	3.28	2.71	6.00	17.51	4.5	49
PBA439(x/xx)-QB15	12x12	25	3.75	3.33	7.08	16.42	4.5	49
PBA439(x/xx)-QB30	12x12	50	3.75	3.33	7.08	53.15	9.0	110
PBA439(x/xx)-QB60	12x12	100	3.75	3.33	7.08	113.39	18.0	220
PBA439(x/xx)-BB30	11.8x15.7	50	4.59	4.10	8.69	51.54	9.0	110
PBA439(x/xx)-BB60	11.8x15.7	100	4.59	4.10	8.69	111.78	18.0	220
PBA439(x/xx)-B30	15.7x19.7	50	7.61	6.28	13.89	46.34	9.0	110
PBA439(x/xx)-B60	15.7x19.7	100	7.61	6.28	13.89	106.57	18.0	220
PBA439(x/xx)-B150	15.7x19.7	250	7.61	6.28	13.89	177.04	45.0	441
PBA439(x/xx)-BC60	19.7x25.6	100	15.43	12.79	28.22	92.24	18.0	220
PBA439(x/xx)-BC150	19.7x25.6	250	15.43	12.79	28.22	157.86	45.0	551
PBA439(x/xx)-BC300	19.7x25.6	500	15.43	12.79	28.22	574.09	90.0	1102
PBA439(x/xx)-CC60	23.6x29.5	100	20.64	24.25	44.89	75.58	18.0	220
PBA439(x/xx)-CC150	23.6x29.5	250	20.64	24.25	44.89	256.27	45.0	551
PBA439(x/xx)-CC300	23.6x29.5	500	20.64	24.25	44.89	557.43	90.0	1102
PBA439(x/xx)-CC600	23.6x29.5	1000	25.35	31.09	56.44	597.03	180.0	1653

## 6.6 Accessories

### Column

Article #	Designation	Description
72229393	Column open 120 mm / 4.7"	Fits for all platform size
72198702	Column open 330 mm / 13"	Fits for all platform size
72198703	Column open 660 mm / 26"	Fits for all platform size
72198704	Column open 900 mm / 35.4"	Fits for all platform size larger than A-size

### Stainless Steel Cart

Article #	Designation	Description
72225939	Stainless steel cart BC	Fits for BC-size platform
72225940	Stainless steel cart CC	Fits for CC-size platform

### Roller Track

Article #	Designation	Description
30253326	Roller track 400 × 500 mm / 15.7" × 19.7" stainless steel	Fits for B-size platform. Roll to short side of platform
30253328	Roller track 500 × 650 mm / 19.7" × 25.6" stainless steel	Fits for BC-size platform. Roll to short side of platform
30253330	Roller track 600 × 800 mm / 23.6" × 31.5" stainless steel	Fits for CC-size platform. Roll to short side of platform
30253327	Roller track 400 × 500 mm / 15.7" × 19.7" stainless steel	Fits for B-size platform. Roll to long side of platform
30253329	Roller track 500 × 650 mm / 19.7" × 25.6" stainless steel	Fits for BC-size platform. Roll to long side of platform
30253331	Roller track 600 × 800 mm / 23.6" × 31.5" stainless steel	Fits for CC-size platform. Roll to long side of platform
30640393	Roller track 400 × 500 mm / 15.7" × 19.7" stainless steel	Fits for hazardous area
30640394	Roller track 500 × 650 mm / 19.7" × 25.6" stainless steel	Fits for hazardous area
30640395	Roller track 600 × 800 mm / 23.6" × 31.5" stainless steel	Fits for hazardous area

### Front Mount Bracket

Article #	Designation	Description
22021062	Front mount bracket	Fit for ICS4_9 front mount

### Stainless Steel Platter

Article #	Designation	Description
30676769	AISI 316 stainless steel platter 240 x 300 mm / 9.5" x 11.8"	Fits for A-size platform
30676770	AISI 316 stainless steel platter 300 x 400 mm / 11.8" x 15.7"	Fits for BB-size platform
30676771	AISI 316 stainless steel platter 400 x 500 mm / 15.7" x 19.7"	Fits for B-size platform
30676772	AISI 316 stainless steel platter 228 x 228 mm / 9" x 9"	Fits for QA-size platform
30676773	AISI 316 stainless steel platter 305 x 305 mm / 12" x 12"	Fits for QB-size platform
30676774	AISI 316 stainless steel platter 500 x 650 mm / 19.7" x 25.6"	Fits for BC-size platform

Article #	Designation	Description
30676775	AISI 316 stainless steel platter, thickness 2.0 mm, 600 x 800 mm / 23.6" x 31.5"	Fits for CC-size platform
30676776	AISI 316 stainless steel platter, thickness 2.5 mm, 600 x 800 mm / 23.6" x 31.5"	Fits for CC-size platform



## 7 Mounting Possibilities

The PBA439(x/xx) supports mounting on stable device. In case drilling on the weighing platform is required, follow the drilling pattern below.



**NOTE: The shadow areas are where drilling on the weighing platform is allowed.**

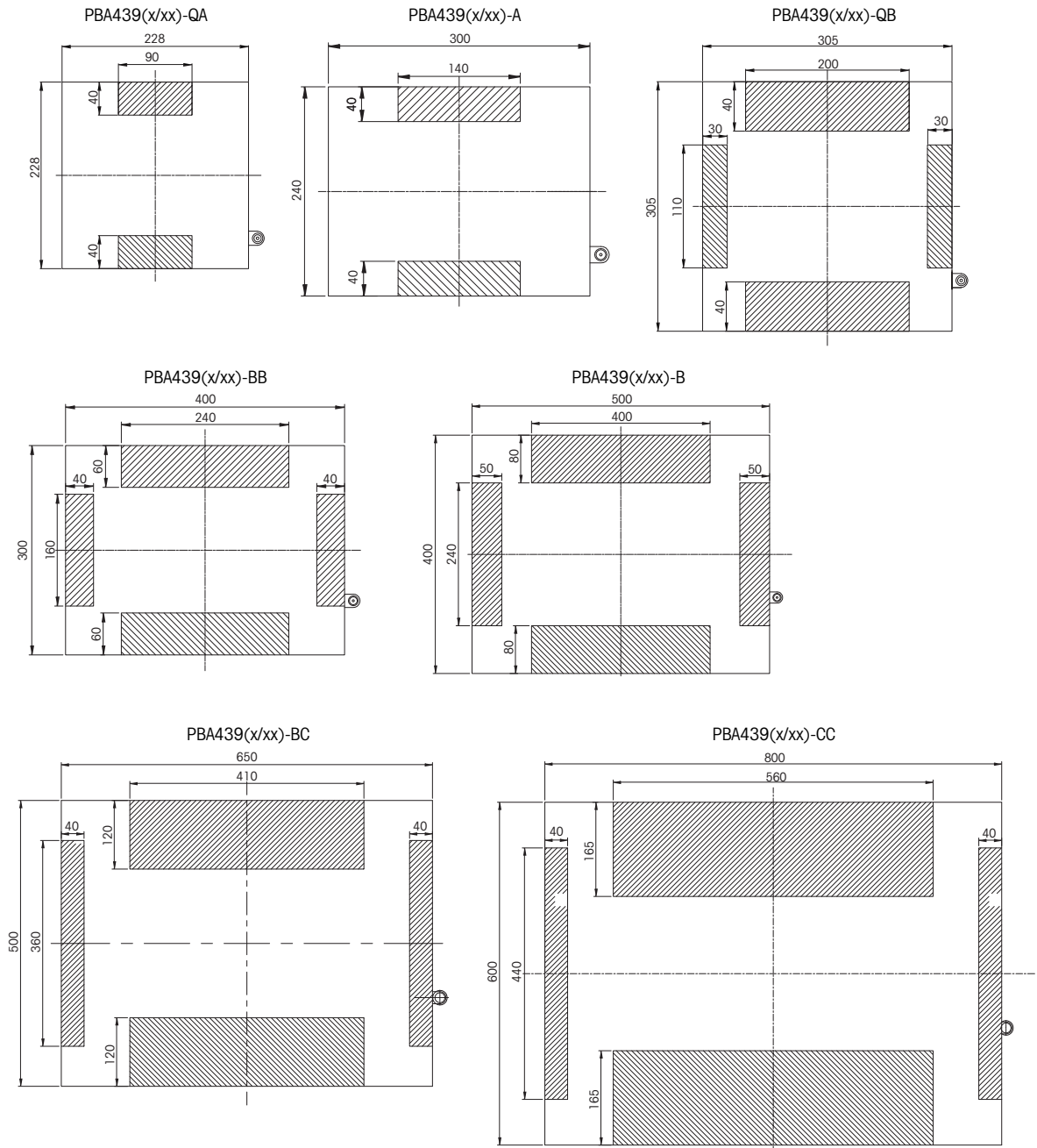

Measured in [mm]



## 8 Appendix

### 8.1 Label

<p>IS CL I,II,III DIV 1, GP ABCDEFG T6...T4          Class I, Zone 1, AEx ia IIC T6...T4 Gb          Class II,III, Zone 21, AEx ia IIIC T80°C Db          -40°C ≤ Ta ≤ 60°C T5/T4; -40°C ≤ Ta ≤ 40°C T6          FM21US0076X</p>			<p>II 2G Ex ia IIC T6...T4 Gb          II 2D Ex ia IIIC T80°C Db          -40°C ≤ Ta ≤ 60°C T5/T4          -40°C ≤ Ta ≤ 40°C T6</p>
<p>IS CL I,II,III DIV 1, GP ABCDEFG T6...T4          Class I, Zone 1, Ex ia IIC T6...T4 Gb          Class II,III, Zone 21, Ex ia IIIC T80°C Db          -40°C ≤ Ta ≤ 60°C T5/T4; -40°C ≤ Ta ≤ 40°C T6          FM21CA0051X</p>		<p>Entity/NIFW for Nonincendive Field Wiring. Entity parameters are shown in drawing 30688074          Mettler-Toledo GmbH, Im Langacher 44, 8606 Greifensee, Switzerland</p>	

<p>NI CL I,II,III DIV 2 GP ABCDFG T6          -40°C ≤ Ta ≤ 60°C          FM21US0076X</p>			<p>II 3G Ex ic IIC T6...T4 Gc          -40°C ≤ Ta ≤ 60°C T5/T4          -40°C ≤ Ta ≤ 40°C T6</p>
<p>NI CL I,II,III DIV 2 GP ABCDEFG T6...T4          -40°C ≤ Ta ≤ 60°C          Class I, Zone 2, Ex ec IIC T6 Gc;          Class II,III, Zone 22, Ex tc IIIC T80°C Dc          FM21CA0051X</p>		<p>II 3G Ex ec IIC T6 Gc U-rated=20V          II 3D Ex tc IIIC T80°C Dc I-rated=50mA          -40°C ≤ Ta ≤ 60°C</p>	
		<p>Entity/NIFW for Nonincendive Field Wiring. Entity parameters are shown in drawing 30688074          Mettler-Toledo GmbH, Im Langacher 44, 8606 Greifensee, Switzerland</p>	



### 8.3 Installation Drawing

#### Hazardous (Classified) Location

IP67 II 3G Ex ic IIC T6...T4 Gc  
-40°C≤Tas60°C T5/T4; -40°C≤Tas40°C T6

II 3G Ex ec IIC T6 Gc -40°C≤Tas60°C T6  
II 3D Ex tc IIIC T80°C Dc  
FM21UKEX0080X  
FM21ATEX0025X IECEX FMG21.0003X

---

II 2G Ex ia IIC T6...T4 Gb  
-40°C≤Tas60°C T5/T4; -40°C≤Tas40°C T6

II 2D Ex ia IIIC T80°C Db  
FM21UKEX0079X  
FM21ATEX0003X IECEX FMG21.0003X

#### Approval Mark

THIS ITEM IS PART OF AGENCY APPROVED PRODUCT

Metrology  
 Safety  
 Ex

DO NOT CHANGE DOCUMENT WITHOUT APPROPRIATE APPROVAL

#### Unclassified Location

SLP84x Load Cell

U<sub>i</sub> = 20V  
l<sub>i</sub> = see table2  
P<sub>i</sub> = see table 2  
C<sub>i</sub> = 6nF  
L<sub>i</sub> = 30uH

+Excitation(Green)

-Excitation(Black)

+SEN(Yellow)

-SEN(Blue)

+Signal(White)

-Signal(Red)

Ex Approved Associated Apparatus with Entity Concept Parameters

U<sub>o</sub> ≤ U<sub>i</sub>  
I<sub>o</sub> ≤ I<sub>i</sub>  
P<sub>o</sub> ≤ P<sub>i</sub>  
C<sub>o</sub> ≥ C<sub>c</sub>+C<sub>i</sub>  
L<sub>o</sub> ≥ L<sub>c</sub>+L<sub>i</sub>

Scale structure (attached to load cell) to be connected to system safety ground. See Note.

NOTES:

- 1.The resistance between all safety ground connections and the system grounding electrode must not exceed 1ohm.
- 2.Installation shall be in accordance with relevant electrical installation standards (Being shown in Table 1)in hazardous areas(other than mines).
- 3.Entity Parameters C<sub>i</sub> And L<sub>i</sub> Include Maximum Load Cell Cable Length Of 30m
- 4.Entity Parameters C<sub>c</sub> and L<sub>c</sub> is the capacitance and inductance of cable connect between load cell and the associated apparatus.
- 5.In an explosive atmosphere caused by air/dust mistures, the loose ends of the cable shall be connected outside the hazardous area or in a suitable enclosure with a degree of protection of at least IP6X in accordance with EN 60529.
- 6.For the application of Ex ec, Ex tc: U<sub>rated</sub>=20V,I<sub>rated</sub>=50mA.
- 7.Installation of load cell needs to be done in such way that enclosure welded caps are physically obstructed from any possible impact.
8. ⚠ Not following these instructions will jeopardize the explosion safety.
9. For the application of Ex ec, The equipment shall only be used in an area of at least pollution degree 2, as defined in IEC 60664-1.

Table 1

EN60079-0: 2018	EN60079-14: 2014	EN60079-11: 2012	EN60079-31: 2014
EN61241-14: 2004	EN60079-31: 2013	EN60079-7: 2015	IEC60079-31: 2013
IEC 60079-0-2017	IEC 60079-11-2011	IEC 60079-14-2013	IEC60079-7: 2015

Table 2

Temperature class	P <sub>i</sub>	l <sub>i</sub>
T4	2.1W	800mA
T5	1.2W	600mA
T6	0.6W	600mA

Mettler-Toledo GmbH, Im Langacher 44, 8606 Greifensee, Switzerland  
Mettler-Toledo Ltd. 64 Boston Rd.Leicester, LE4 1AW, United Kingdom

D	update drawing status	Wang Jianwen	Liu Yuchun				2021-7-26
C	removed Ex nA of note6	Wang Jianwen	Liu Yuchun				2021-1-15
REV / CHG	ZONE DESCRIPTION	BY	APPVD	AGENCY	E.R. No.	DATE	
RECORD OF CHANGES							
<b>METTLER TOLEDO</b>		MTCZ	Drawn	Wang JW	2020/05/11	Scale	1:1
		CN-213022 ChangZhou	Change			Format	mt_A4
Refer to protection notice ISO 16016 / Schutzvermerk ISO 16016 beachten			Note	-		Replaces	-
Description 防爆安装图 SLP84X			ERP NO.			ERP Rev	
<b>INSTALLATION DRAWING SLP84X ATEX/IECEX</b>							<b>D</b>
External Design No.:D000644580		External Design Rev.:D	Status:Approved	Mass:	Units:mm		1/1

AutoCAD Mechanical Template V0.2

# METTLER TOLEDO Service

Herzlichen Glückwunsch zu Ihrer Entscheidung für die Qualität und Präzision von METTLER TOLEDO. Die richtige Verwendung Ihres neuen Geräts entsprechend diesem Benutzerhandbuch sowie die regelmäßige Kalibrierung und Wartung durch unser geschultes Kundendienstteam gewährleisten den zuverlässigen und genauen Betrieb und schützen Ihre Investition. Setzen Sie sich mit uns in Verbindung, um eine Servicevereinbarung entsprechend Ihren Anforderungen und Ihrem Budget abzuschließen. Weitere Informationen können unter ► [www.mt.com/service](http://www.mt.com/service) abgerufen werden.

Es gibt verschiedene Möglichkeiten zur Maximierung der Ergebnisse Ihrer Investition:

- 1 **Registrieren Sie Ihr Produkt:** Wir laden Sie ein, Ihr Produkt unter [www.mt.com/productregistration](http://www.mt.com/productregistration) zu registrieren.  
So können wir Sie über Verbesserungen, Aktualisierungen und wichtige Benachrichtigungen für Ihr Produkt informieren.
- 2 **Wenden Sie sich an METTLER TOLEDO, wenn eine Wartung erforderlich ist:** Ein Messergebnis ist nur so viel wert wie seine Genauigkeit – eine nicht spezifikationskonforme Waage stellt ein Qualitäts-, Gewinn- und Haftungsrisiko dar. Die termingerechte Wartung durch METTLER TOLEDO sorgt für Genauigkeit sowie maximale Verfügbarkeit und Lebensdauer.
  - ➔ **Installation, Konfiguration, Integration und Schulung:** Unsere Servicemitarbeiter sind werksseitig geschulte Experten für Wägausrüstung. Wir stellen sicher, dass Ihre Wägausrüstung rasch und kostengünstig betriebsbereit ist und dass Ihre Mitarbeiter optimal geschult werden.
  - ➔ **Dokumentation der Erstkalibrierung:** Die Installationsumgebung und Applikationsanforderungen sind für jede Industriewaage einzigartig, daher muss die Leistung überprüft und bestätigt werden. Im Rahmen unserer Kalibrierservices prüfen und dokumentieren wir die Genauigkeit und stellen somit die Produktionsqualität sicher. Außerdem liefern wir erstklassige Systemleistungsdaten.
  - ➔ **Regelmäßige Kalibrierung und Wartung:** Ein Kalibrierservicevertrag bietet Ihnen kontinuierliches Vertrauen in Ihren Wägeprozess sowie eine Dokumentation der Einhaltung von Vorschriften. Wir haben zahlreiche Servicepläne im Angebot, die Ihre Bedürfnisse und Ihr Budget im Blick haben.



# Inhaltsverzeichnis

<b>1</b>	<b>Sicherheitshinweise</b>	<b>3</b>
1.1	Bestimmungsgemäße Verwendung .....	3
1.2	Missbräuchliche Verwendung .....	3
1.3	Sicherheitsvorkehrungen .....	3
1.4	Besondere Nutzungsbedingungen .....	4
<b>2</b>	<b>Einführung</b>	<b>5</b>
2.1	Produktsortiment .....	5
2.2	Zu diesem Handbuch .....	5
2.3	Weitere Dokumente .....	5
<b>3</b>	<b>Installation und Betrieb</b>	<b>6</b>
3.1	Anschließen der Wägebrücke am Wägeterminal .....	6
3.2	Nivellieren .....	7
3.3	Potenzialausgleich .....	7
3.4	Prüfen der Wägebrücke .....	7
3.5	Bedienen der Wägebrücke .....	8
3.6	Installation, Konfiguration, Service und Reparatur .....	8
<b>4</b>	<b>Wartung</b>	<b>9</b>
4.1	Hinweise zur Reinigung .....	9
4.2	Nachbehandlung .....	9
4.3	Entsorgung .....	10
<b>5</b>	<b>Reparatur</b>	<b>11</b>
<b>6</b>	<b>Technische Daten und Betriebsgrenzen</b>	<b>12</b>
6.1	Maximaler Eichwert .....	12
6.2	Maximal zulässige Belastung .....	12
6.3	Technische Daten der Wägezelle .....	13
6.3.1	Ex-Zulassung .....	13
6.3.2	Einzuhaltende Norm Wägezelle .....	13
6.4	Abmessungen .....	15
6.5	Angaben zu Kapazität und Vorlast .....	16
6.5.1	Vorlast-Tabelle in Kilogramm .....	17
6.5.2	Vorlast-Tabelle in Pfund .....	18
6.6	Zubehör .....	19
<b>7</b>	<b>Montagemöglichkeiten</b>	<b>21</b>
<b>8</b>	<b>Anhang</b>	<b>22</b>
8.1	Aufkleber .....	22
8.2	Kontrollzeichnung .....	23
8.3	Einbauzeichnung .....	24





# 1 Sicherheitshinweise

## 1.1 Bestimmungsgemäße Verwendung

Wägebrücken der Produktserie PBA439(x/xx) sind Teil eines modularen Wägesystems, bestehend aus einem Wägeterminal von METTLER TOLEDO als Anzeige und mindestens einer Wägebrücke.

- Die Wägebrücke darf ausschließlich für Wägevorgänge in Übereinstimmung mit dieser Anleitung verwendet werden.
- Die Wägebrücke ist nur zur Verwendung im Innenbereich bestimmt.
- Nur Wägebrücken der Produktserie PBA439x/xx sind gemäß den nachfolgenden Angaben für den Einsatz in explosionsgefährdeter Umgebung geeignet.
- Jede andere Art der Verwendung gilt als nicht bestimmungsgemäß.

### Eichpflichtiger Verkehr

- Für eine Verwendung im eichpflichtigen Verkehr nur geeichte Wägebrücken verwenden.
- Bei einer Verwendung im eichpflichtigen Verkehr ist der Betreiber für die Einhaltung aller nationalen Vorschriften in Bezug auf Maße und Gewichte zuständig.
- Wenden Sie sich bei Fragen bezüglich des Einsatzes in eichpflichtigen Anwendungen an die METTLER TOLEDO Serviceorganisation.

## 1.2 Missbräuchliche Verwendung

- Das Wägeterminal ausschließlich für Wägevorgänge verwenden.
- Die Wägebrücke nicht in einer anderen als der im --- MISSING LINK --- spezifizierten Umgebung einsetzen.
- Keine Änderungen an der Wägebrücke vornehmen.
- Das Wägeterminal nicht für den Betrieb außerhalb der in den technischen Daten vorgegebenen Grenzen verwenden.
- Die Wägebrücke nicht als Aufbewahrungsort von Gütern verwenden.
- Das Herabfallen von Gegenständen auf die Wägebrücke vermeiden.

## 1.3 Sicherheitsvorkehrungen

- Die Wägebrücke darf nur von Personal installiert und gewartet werden, das von METTLER TOLEDO entsprechend geschult und qualifiziert wurde.
- Beim Transportieren oder Anheben schwerer Geräte vorsichtig vorgehen.
- Die Stromquelle der Wägebrücke vor Installation, Instandhaltung, Reinigung oder Wartung immer unterbrechen.
- Das Verbindungskabel darf erst getrennt werden, wenn das Wägeterminal ausgeschaltet ist.
- Vor Einschalten der Stromversorgung sicherstellen, dass die Wägebrücke Raumtemperatur erreicht hat.
- Die explosionsgeschützten Wägebrücken PBA439x/xx sind für den Betrieb in folgenden explosionsgefährdeten Bereichen zugelassen:
  - ATEX/IECEx Kategorie 2, Kategorie 3, Gas/Staub (Zone 1/21, Zone 2/22)
  - cFMus, Klasse I,II,III, Div. 1, Div. 2
- Bei Verwendung von Wägebrücken in explosionsgefährdeten Bereichen besteht eine erhöhte Gefahr von Verletzungen und Beschädigungen! Bei Arbeiten in solchen Bereichen gilt besondere Sorgfaltspflicht.
- Bei Wägebrücken der Produktserie PBA439x/xx ausschließlich Kabelverschraubungen für das Einführen des Wägezellenkabels in das Wägeterminal verwenden, die sich für explosionsgefährdete Bereiche eignen und für diese Bereiche zugelassen sind.
- Explosionsgeschützte Wägebrücken dürfen in explosionsgefährdeten Bereichen nur zusammen mit Wägeterminals verwendet werden, die die entsprechenden Zulassungs- und Schnittstellenspezifikationen aufweisen.

## 1.4 Besondere Nutzungsbedingungen

- In einer durch Luft-/Staubfeuchtigkeit verursachten explosionsfähigen Atmosphäre müssen die losen Enden des Kabels außerhalb des explosionsgefährdeten Bereichs oder in einem geeigneten Gehäuse mit einem Schutzgrad von mindestens IP6X gemäß IEC/EN 60529 angeschlossen werden.

## 2 Einführung

### 2.1 Produktsortiment

In dieser Bedienungsanleitung wird der Schwerpunkt auf die Produktserie PBA439(x/xx) gelegt.

Die Serie PBA439(x/xx) bietet eine Vielzahl an Wägebrücken, die auf Ihre Anforderungen abgestimmt sind. Die Serie bietet eichfähige Produkte mit einer Vielzahl an Größen und Kapazitäten.

Typ	Lastplatte Material	Waagenrahmen Material	Wägezelle Auslegung	IP-Schutzart Umgebung	Zulassung explosions- gefährdete Bereiche
PBA439	Edelstahl AISI304	Edelstahl AISI304	Edelstahl, herme- tisch versiegelt	Trocken, nass, IP68/IP69K	-
PBA439x					Zone 1/21, Div 1
PBA439xx					Zone 2/22, Div 2

### 2.2 Zu diesem Handbuch



Dieses Handbuch enthält alle Informationen für den Bediener des Produkts.

- Dieses Handbuch vor der Verwendung sorgfältig durchlesen.
- Dieses Handbuch für künftige Referenzzwecke aufbewahren.
- Dieses Handbuch an künftige Eigentümer oder Benutzer des Produkts weitergeben.

### 2.3 Weitere Dokumente

Außer diesem Handbuch in Druckform können Sie über ► [www.mt.com](http://www.mt.com) die folgenden Dokumente herunterladen:

- Broschüre
- Installationsanleitung (für geschultes Personal unter Aufsicht des Betreibers)
- Dokumente zur Bauartzulassung

#### Zertifikat-Download

US-, Kanada-, ATEX-, UKEX- und IECEx-Zertifikate können unter

► <https://www.mt.com/us/en/home/search/compliance.html/compliance/> heruntergeladen werden.

## 3 Installation und Betrieb

### 3.1 Anschließen der Wägebrücke am Wägeterminal

Die Wägebrücken der Serie PBA439(x/xx) sind für den Einsatz mit analogen Wägeterminals von METTLER TOLEDO ausgelegt.

- 1 Wägebrückenkabel durch die Kabelverschraubung ins Wägeterminal einziehen.
- 2 Das Wägebrückenkabel entsprechend der nachfolgenden Tabelle an der Klemmleiste des Wägeterminals anschließen.

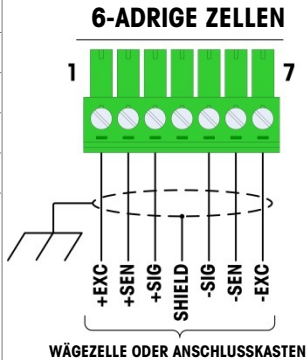
Signal	Farbe des Kabels	Anschluss
SIG+	Weiß	 <p><b>6-ADRIGE ZELLEN</b></p> <p>1 7</p> <p>+EXC +SEN +SIG SHIELD -SIG -SEN -EXC</p> <p>WÄGEZELLE ODER ANSCHLUSSKASTEN</p>
SIG-	Rot	
EXC+	Grün	
EXC-	Schwarz	
SEN+	Gelb	
SEN-	Blau	



#### **! WARNUNG**

**Der Kabelschirm muss geerdet werden.**

#### **Sicherheitsvorkehrungen für Verbindungen**

- Beim Anschluss der Wägebrücke in explosionsgefährdeten Bereichen sind die Anforderungen gemäß der im [Anhang ▶ Seite 22] verfügbaren Kontrollzeichnung strikt einzuhalten.
- Beachten Sie bitte die besonderen Bedingungen für die sichere Verwendung in den Zeichnungen und den Zertifikaten im [Anhang ▶ Seite 22].
- Der Kabelschirm ist mit dem Federelement der Wägezelle (dem Gehäuse der Wägezelle) verbunden. Achten Sie bitte darauf, eine geeignete Verbindung zwischen Wägezelle und Terminal (oder Anschlusskasten) je nach Einbausituation herzustellen.
- Der Widerstand zwischen allen Sicherheitserdungsverbindungen und der Erdungselektrode des Systems darf 1 Ohm nicht überschreiten.
- Die Installation muss in Übereinstimmung mit den einschlägigen Normen für die Elektroinstallation erfolgen.
- Die Nichtbeachtung dieser Anweisungen führt zu einer Gefährdung der Explosionssicherheit.

## 3.2 Nivellieren

Nur eine exakt horizontal ausgerichtete Wägebrücke liefert genaue Wägeregebnisse. Die Wägebrücke muss bei der Erstinstallation und bei jedem Standortwechsel nivelliert werden.

- 1 Die Stellfüße der Wägebrücke drehen, bis die Luftblase der Libelle im inneren Kreis liegt.
- 2 Kontermuttern der Stellfüße festziehen.

☞ Scannen Sie den QR-Code, um das Video an

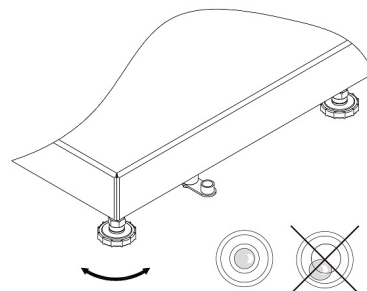

## 3.3 Potenzialausgleich

Der Potenzialausgleich für die Wägebrücken der Serie PBA439x/xx ist werkseitig montiert. Die Verdrahtung muss am Standort des Kunden von einer Elektrofachkraft installiert werden. Der METTLER TOLEDO Service hat hierbei nur eine überwachende und beratende Funktion. Die Potenzialausgleiche (PA) aller Geräte (Wägebrücke und Wägeterminal) in Übereinstimmung mit landesspezifischen Vorschriften und Normen verbinden. Dabei sicherstellen, dass alle Gerätegehäuse über die PA-Klemme auf dem gleichen Potenzial liegen.

### Hinweis

Das Gerät ist gemäß IEC60950, Klasse II, gegen Stromschlag geschützt.

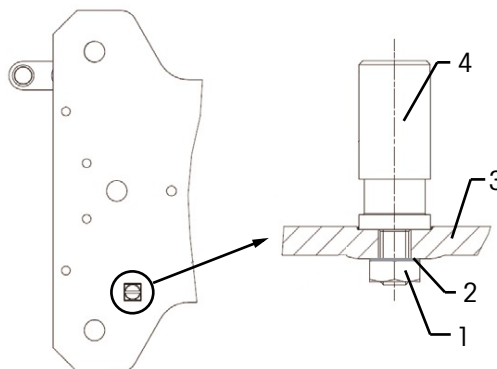

- 1 - Sechskantmutter, M4 KEPS
- 2 - Unterlegscheibe
- 3 - Grundrahmen
- 4 - Potenzialausgleichsanschluss, Anzugsmoment 3,5 Nm

Bestellnummer des Potenzialausgleichskits 72237321

## 3.4 Prüfen der Wägebrücke

### Funktionsprüfung

- 1 Sicherstellen, dass die Wägebrücke mit einem Wägeterminal verbunden ist und dass das Wägeterminal eingeschaltet ist.
- 2 Sicherstellen, dass die Wägebrücke entlastet ist und die Anzeige des Wägeterminals 0 anzeigt.
- 3 Wägebrücke belasten. Das Wägeterminal muss einen Wert ungleich 0 anzeigen.
- 4 Wägebrücke entlasten. Das Wägeterminal muss auf 0 zurückgehen.

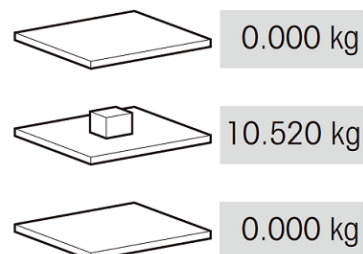

### Eichtest

Für Informationen zum Eichtest siehe die Bedienungsanleitung des Wägeterminals. Wird das Eichsiegel beschädigt, ist die Eichung nicht länger gültig.

### 3.5 Bedienen der Wägebrücke

Für optimale Wäageergebnisse die folgenden Punkte beachten:

- Stellen Sie sicher, dass die Lastplatte korrekt platziert ist.

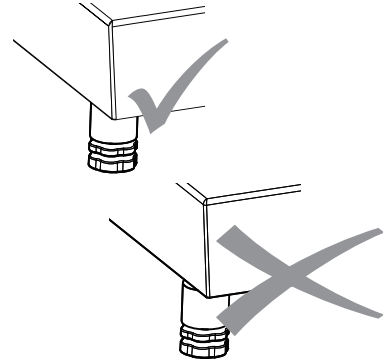

- Um optimale Wäageergebnisse zu erzielen, das Wäagegut immer an derselben Stelle auf der Wägebrücke platzieren.

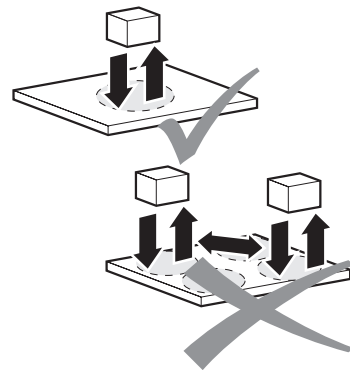

- Abrieb- und Verschleißprozesse vermeiden.

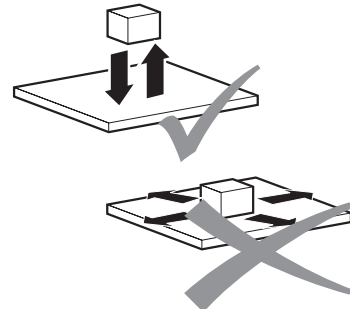

- Fallende Lasten, Schockbelastungen sowie seitliche Stöße vermeiden.

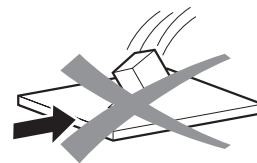

### 3.6 Installation, Konfiguration, Service und Reparatur

Wenden Sie sich für Installation, Konfiguration, Service und Reparatur der Wäagebrücken an den METTLER TOLEDO Service.

## 4 Wartung

### 4.1 Hinweise zur Reinigung

#### Hinweis

##### Fehlgebrauch von Reinigungsmitteln kann zu Beschädigungen der Wägebrücke führen.

- Desinfektions- und Reinigungsmittel nur entsprechend den Anleitungen des jeweiligen Herstellers verwenden.
- Keine hochsauren, hochalkalischen Reinigungsmittel oder Reinigungsmittel mit hohem Chlorgehalt verwenden. Substanzen mit hohem oder niedrigem pH-Wert vermeiden, da ansonsten eine höhere Korrosionsgefahr besteht.
- Bei der Reinigung der Wägezelle sehr vorsichtig vorgehen.

#### Reinigungsverfahren

- Schmutz und Ablagerungen müssen sowohl außen als auch im Innern der Wägebrücke regelmäßig entfernt werden.
  - ➔ Das Vorgehen richtet sich dabei nach der Art der Oberfläche sowie nach den am Aufstellort herrschenden Umgebungsbedingungen.

#### Reinigung in feuchter Umgebung (Edelstahlausführungen)

- Wasserstrahl bis zu 80 °C / 176 °F und max. 80 bar verwenden, Mindestabstand 40 cm / 16".
- Haushaltsreiniger verwenden.

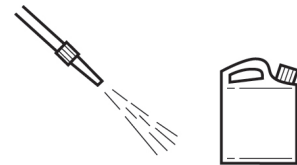

#### Reinigung in korrosiver Umgebung (Edelstahlausführungen)

- Wasserstrahl verwenden.
  - Innenreinigung**, Wägezelle, Lastplatte geöffnet: bis zu 60 °C / 140 °F und max. 2 bar, Mindestabstand 40 cm / 16".
  - Außenreinigung**, Lastplatte geschlossen: bis zu 80 °C / 176 °F und max. 80 bar, Mindestabstand 40 cm / 16".
- Korrosive Substanzen in regelmäßigen Abständen entfernen.
- Desinfektions- und Reinigungsmittel nur entsprechend den Spezifikationen und Anleitungen des jeweiligen Herstellers verwenden.

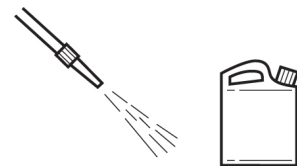

### 4.2 Nachbehandlung

Zum Schutz der Waage folgende Nachbehandlung durchführen:

- Waage mit klarem Wasser abspülen und Reinigungsmittel restlos entfernen.
- Waage mit einem fusselfreien Lappen abtrocknen.
- Bei Edelstahlwaagen die Innen- und Außenseiten mit einem nahrungsmittelverträglichen Öl behandeln.

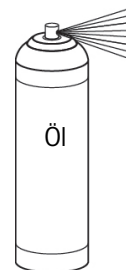

### 4.3 Entsorgung

Entsprechend der europäischen Richtlinie 2012/19/EU über Elektro- und Elektronik-Altgeräte (WEEE) darf dieses Gerät nicht im Haushaltsabfall entsorgt werden. Dies gilt auch für Länder außerhalb der EU entsprechend den geltenden nationalen Regelungen.

Bitte entsorgen Sie dieses Produkt gemäß den örtlichen Bestimmungen in einer getrennten Sammlung für Elektro- und Elektronikgeräte. Bei Fragen wenden Sie sich bitte an die zuständige Behörde oder den Händler, bei dem Sie dieses Gerät erworben haben. Bei einer Weitergabe an Dritte muss der Inhalt dieser Regelung ebenfalls mit einbezogen werden.





## 5 Reparatur

Dieses Gerät ist für die Verwendung in explosionsgefährdeten Bereichen zertifiziert, daher sind keine Änderungen zulässig. Reparaturen dürfen nur von Personen durchgeführt werden, die speziell für Reparaturen an diesem Gerät geschult wurden.

## 6 Technische Daten und Betriebsgrenzen

### 6.1 Maximaler Eichwert

Max. Eichwert [e] / OIML	Kapazität							
	3 kg	6 kg	15 kg	30 kg	60 kg	150 kg	300 kg	600 kg
1 x 3000e Max / e [kg]	3 / 0.001	6 / 0.002	15 / 0.005	30 / 0.01	60 / 0.02	150 / 0.05	300 / 0.1	600 / 0.2

Max. Eichwert [d] / NTEP	Kapazität							
	-	10 lb	25 lb	50 lb	100 lb	250 lb	500 lb	1000 lb
1 x 5000d Max / d [lb]	-	10 / 0.002	25 / 0.005	50 / 0.01	100 / 0.02	250 / 0.05	500 / 0.1	1000 / 0.2

### 6.2 Maximal zulässige Belastung

Alle Wägebrücken sind mit einem Überlastschutz ausgestattet. Die Wägebrücke ist so robust konstruiert, dass ein gelegentliches Überschreiten der maximalen Wägelast zu keinen Schäden führt. Die maximale statische Tragfähigkeit darf nicht überschritten werden.

- Beachten Sie die folgenden Beschränkungen für den Betrieb.

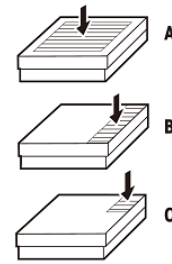

Modell	A - Zentrische Last	B - Seitliche Last	C - Eckenlast
PBA439(x/xx)-QA	40 kg / 80 lb	30 kg / 60 lb	15 kg / 30 lb
PBA439(x/xx)-A	40 kg / 80 lb	30 kg / 60 lb	15 kg / 30 lb
PBA439(x/xx)-QB	100 kg / 200 lb	70 kg / 140 lb	35 kg / 70 lb
PBA439(x/xx)-BB	100 kg / 200 lb	70 kg / 140 lb	35 kg / 70 lb
PBA439(x/xx)-B	200 kg / 400 lb	140 kg / 280 lb	75 kg / 150 lb
PBA439(x/xx)-BC	400 kg / 800 lb	300 kg / 600 lb	150 kg / 300 lb
PBA439(x/xx)-CC	700 kg / 1400 lb	400 kg / 800 lb	200 kg / 400 lb



#### **! WARNUNG**

**Fallende Lasten, Schockbelastungen sowie seitliche Stöße vermeiden.**

## 6.3 Technische Daten der Wägezelle

Nennausgangsspannung	mV/V	1,8 ± 0,2
Eingangswiderstand	Ω	384 ± 15
Ausgangswiderstand	Ω	350 ± 4
Empfohlene Spannung	V (DC / AC)	5 - 15
Max. Erregungsspannung	V (DC / AC)	20
Kabelschirm	-	PVC
IP-Schutzklasse	-	IP68/IP69K

### 6.3.1 Ex-Zulassung

In diesem Abschnitt werden nur die Ex-relevanten Aspekte des Produkts behandelt.

Die Wägezelle SLP84x(x=6,7,8) wurde mit folgenden Zertifikaten versehen:

ATEX-Zertifikat	FM21ATEX0003X, FM21ATEX0025X
UK-Zertifikat	FM21UKEX0079X, FM21UKEX0080X
IECEx-Zertifikat	IECEx FMG21.0003X
US-Zertifikat	FM21US0005X
Kanadisches Zertifikat	FM21CA0002X

Die oben aufgeführten Zertifikate und die zugehörigen Installationszeichnungen finden Sie im [Anhang ▶ Seite 22].

### 6.3.2 Einzuhaltende Norm Wägezelle

#### US-Normen

Titel	Nummer	Ausgabedatum
Electrical Equipment for Use in Hazardous (Classified) Locations – General Requirements	FM Class 3600	2018
Intrinsically Safe Apparatus and Associated Apparatus for Use in Class I, II, and III, Division 1, Hazardous (Classified) Locations	FM Class 3610	2021
Nonincendive Electrical Equipment for Use in Class I and II, Division 2, and Class III, Divisions 1 and 2, Hazardous (Classified) Locations	FM Class 3611	2021
Electrical Equipment for Measurement, Control and Laboratory Use	FM Class 3810	2021
Explosive atmospheres - Part 0: Equipment - General requirements	ANSI/UL 60079-0	2019
Explosive atmospheres – Part 11: Equipment protection by intrinsic safety "i"	ANSI/ISA 60079-11	2014
Nonincendive electrical equipment for use in Class I and II, Division 2 and Class III, Divisions 1 and 2 hazardous (classified) locations	ANSI/UL 121201	2017
Safety Requirements for Electrical Equipment for Measurement, Control, and Laboratory Use – Part 1: General Requirements	ANSI/UL 61010-1	2012
Degrees of Protection Provided by Enclosures (IP Code)	ANSI/IEC 60529	2020

#### Kanadische Normen

Titel	Nummer	Ausgabedatum
Non-Incendive Electrical Equipment for use in Class I, Division 2 Hazardous Locations	CSA C22.2 No. 213	2017
Explosive atmospheres - Part 0: Equipment - General requirements	CAN/CSA-C22.2 No. 60079-0	2019
Explosive atmospheres - Part 11: Equipment protection by intrinsic safety "i"	CAN/CSA-C22.2 No. 60079-11	2014
Explosive atmospheres - Part 7: Equipment protection by increased safety "e"	CAN/CSA-C22.2 No. 60079-7	2018

Titel	Nummer	Ausgabedatum
Explosive atmospheres - Part 31: Equipment dust ignition protection by enclosure "T"	CAN/CSA-C22.2 No. 60079-31	2015
Safety Requirements for Electrical Equipment for Measurement, Control, and Laboratory Use – Part 1: General Requirements	CSA C22.2 No. 61010-1	2012
Degrees of Protection Provided by Enclosures (IP Code)	CSA C22.2 No. 60529	2016

### IECEx-Normen

Titel	Nummer	Ausgabedatum
Explosionsgefährdete Bereiche - Teil 0: Betriebsmittel - Allgemeine Anforderungen	IEC 60079-0	2017
Explosionsgefährdete Bereiche - Teil 11: Geräteschutz durch Eigensicherheit "i"	IEC 60079-11	2011
Explosionsgefährdete Bereiche - Teil 7: Geräteschutz durch erhöhte Sicherheit "e"	IEC 60079-7	2017
Explosionsgefährdete Bereiche - Teil 31: Geräte-Staubexplosionsschutz durch Gehäuse "T"	IEC 60079-31	2013
Schutzarten durch Gehäuse (IP-Code)	IEC 60529	2013

### ATEX-Normen

Titel	Nummer	Ausgabedatum
Explosionsgefährdete Bereiche - Teil 0: Betriebsmittel - Allgemeine Anforderungen	EN IEC 60079-0	2018
Explosionsgefährdete Bereiche - Teil 11: Geräteschutz durch Eigensicherheit „i“	EN 60079-11	2012
Explosionsgefährdete Bereiche - Teil 7: Geräteschutz durch erhöhte Sicherheit „e“	EN 60079-7	2015 +A1:2018
Explosionsgefährdete Bereiche - Teil 31: Geräte-Staubexplosionsschutz durch Gehäuse "T"	EN 60079-31	2014
Schutzarten durch Gehäuse (IP-Code)	EN 60529	1991 + A1:2000 + A2:2013

### UKEX-Normen

Titel	Nummer	Ausgabedatum
Explosionsgefährdete Bereiche - Teil 0: Betriebsmittel - Allgemeine Anforderungen	EN IEC 60079-0	2018
Explosionsgefährdete Bereiche - Teil 11: Geräteschutz durch Eigensicherheit „i“	EN 60079-11	2012
Explosionsgefährdete Bereiche - Teil 7: Geräteschutz durch erhöhte Sicherheit „e“	EN 60079-7	2015 +A1:2018
Explosionsgefährdete Bereiche - Teil 31: Geräte-Staubexplosionsschutz durch Gehäuse "T"	EN 60079-31	2014
Schutzarten durch Gehäuse (IP-Code)	EN 60529	1991 + A1:2000 + A2:2013

## 6.4 Abmessungen

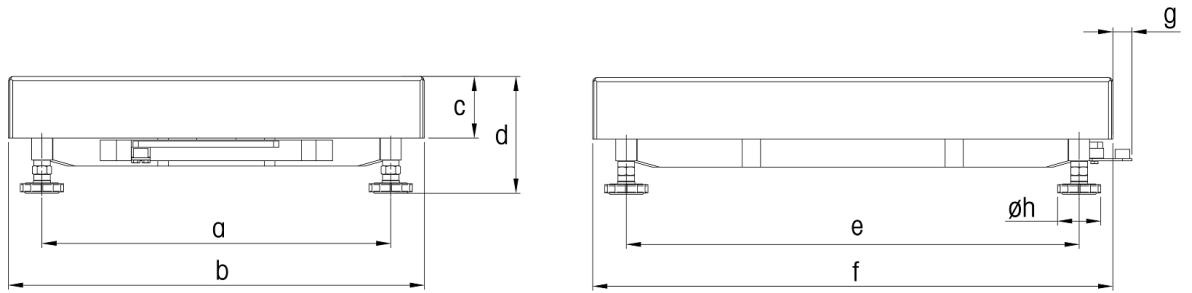

Abmessungen		a	b	c	d *	e	f	g	h
PBA439(x/xx)-QA	mm	163	228	56	85,6	163	228	21	42
	inch	6,42	8,98	2,20	3,37	6,42	8,98	0,83	1,65
PBA439(x/xx)-A	mm	175	240	56	85,6	235	300	21	42
	inch	6,89	9,45	2,20	3,37	9,25	11,81	0,83	1,65
PBA439(x/xx)-QB	mm	240	305	57	96,6	253	305	18	42
	inch	9,45	12,01	2,24	3,8	9,96	12,01	0,71	1,65
PBA439(x/xx)-BB	mm	235	300	57	96,6	335	400	18	42
	inch	9,25	11,81	2,24	3,8	13,19	15,75	0,71	1,65
PBA439(x/xx)-B	mm	335	400	59	100,1	435	500	18	42
	inch	13,19	15,75	2,32	3,94	17,13	19,69	0,71	1,65
PBA439(x/xx)-BC	mm	437	500	73	106,8	584	650	17	42
	inch	17,20	19,69	2,87	4,2	22,99	25,59	0,67	1,65
PBA439(x/xx)-CC	mm	503	600	85	128,3	724	800	18	42
	inch	19,80	23,62	3,35	5,05	28,5	31,50	0,71	1,65

\*: 1) d= Mindestgewicht der Brücke. Mit den verstellbaren Waagenfüßen kann die Höhe der Wägebrücke um maximal 10 mm / 0,39 inch erhöht werden.

2) Mit der Option Hygiene-Kit erhöht sich die Mindesthöhe der Wägebrücke (d) um 12 mm / 0,47 inch.

## 6.5 Angaben zu Kapazität und Vorlast

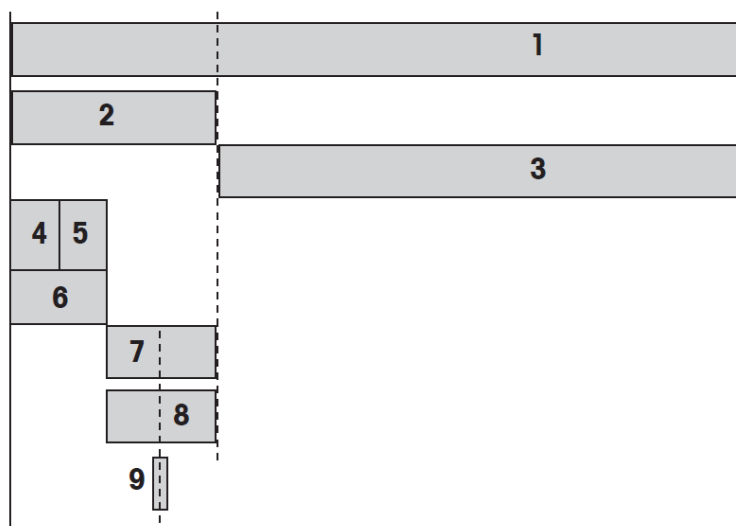

<b>1</b>	Maximaler Lastbereich der Wägezelle ( $E_{\max}$ )
<b>2</b>	Maximale Vorlast = Maximaler Lastbereich <b>1</b> – Maximallast <b>3</b>
<b>3</b>	Maximallast = Maximaler Lastbereich <b>1</b> – Maximale Vorlast <b>2</b>
<b>4</b>	Vorlast Oberteil
<b>5</b>	Vorlast Waagschale
<b>6</b>	Vorlast ab Werk = Vorlast Oberteil <b>4</b> + Vorlast Waagschale <b>5</b>
<b>7</b>	Mechanische Vorlastreserve = Maximale Vorlast <b>2</b> – Vorlast ab Werk <b>6</b>
<b>8</b>	Der Nullstellbereich (Einschalten) kann eingestellt werden. Der Nullstellbereich muss innerhalb der maximalen Vorlast liegen. Der Nullstellbereich darf maximal 18 % der Maximallast betragen.
<b>9</b>	Nullstellbereich $\pm 2$ % der Maximallast

## 6.5.1 Vorlast-Tabelle in Kilogramm

Typ	Abmessungen [mm]	Max. Last (3)	Vorlast Oberteil (4)	Vorlast Waag- schale (5)	Vorlast ab Werk (6)	Mech. Vor- lastre- serve (7)	Null- stellbe- reich (8)	Max. Lastbe- reich (1)
PBA439(x/xx)-QA3	228x228	3	1,04	0,95	1,99	6,01	0,54	11
PBA439(x/xx)-QA6	228x228	6	1,04	0,95	1,99	3,01	1,08	11
PBA439(x/xx)-A3	240x300	3	1,49	1,23	2,72	5,28	0,54	11
PBA439(x/xx)-A6	240x300	6	1,49	1,23	2,72	2,28	1,08	11
PBA439(x/xx)-A15	240x300	15	1,49	1,23	2,72	4,28	2,70	22
PBA439(x/xx)-QB15	305x305	15	1,70	1,51	3,21	3,79	2,70	22
PBA439(x/xx)-QB30	305x305	30	1,70	1,51	3,21	16,79	5,40	50
PBA439(x/xx)-QB60	305x305	60	1,70	1,51	3,21	36,79	10,80	100
PBA439(x/xx)-BB30	300x400	30	2,08	1,86	3,94	16,06	5,40	50
PBA439(x/xx)-BB60	300x400	60	2,08	1,86	3,94	36,06	10,80	100
PBA439(x/xx)-B30	400x500	30	3,45	2,85	6,30	13,70	5,40	50
PBA439(x/xx)-B60	400x500	60	3,45	2,85	6,30	33,70	10,80	100
PBA439(x/xx)-B150	400x500	150	3,45	2,85	6,30	43,70	27,00	200
PBA439(x/xx)-BC60	500x650	60	7,00	5,80	12,80	27,20	10,80	100
PBA439(x/xx)-BC150	500x650	150	7,00	5,80	12,80	35,00	27,00	250
PBA439(x/xx)-BC300	500x650	300	7,00	5,80	12,80	187,20	54,00	500
PBA439(x/xx)-CC60	600x800	60	9,36	11,00	20,36	19,64	10,80	100
PBA439(x/xx)-CC150	600x800	150	9,36	11,00	20,36	79,64	27,00	250
PBA439(x/xx)-CC300	600x800	300	9,36	11,00	20,36	179,64	54,00	500
PBA439(x/xx)-CC600	600x800	600	11,50	14,10	25,60	124,40	108,00	750

## 6.5.2 Vorlast-Tabelle in Pfund

Typ	Abmessungen [inch]	Max. Last (3)	Vorlast Oberteil (4)	Vorlast Waag- schale (5)	Vorlast ab Werk (6)	Mech. Vor- lastre- serve (7)	Null- stellbe- reich (8)	Max. Lastbe- reich (1)
PBA439(x/xx)-QA6	9x9	10	2,29	2,09	4,39	9,86	1,8	24
PBA439(x/xx)-A6	9,5x11,8	10	3,28	2,71	6,00	8,25	1,8	24
PBA439(x/xx)-A15	9,5x11,8	25	3,28	2,71	6,00	17,51	4,5	49
PBA439(x/xx)-QB15	12x12	25	3,75	3,33	7,08	16,42	4,5	49
PBA439(x/xx)-QB30	12x12	50	3,75	3,33	7,08	53,15	9,0	110
PBA439(x/xx)-QB60	12x12	100	3,75	3,33	7,08	113,39	18,0	220
PBA439(x/xx)-BB30	11,8x15,7	50	4,59	4,10	8,69	51,54	9,0	110
PBA439(x/xx)-BB60	11,8x15,7	100	4,59	4,10	8,69	111,78	18,0	220
PBA439(x/xx)-B30	15,7x19,7	50	7,61	6,28	13,89	46,34	9,0	110
PBA439(x/xx)-B60	15,7x19,7	100	7,61	6,28	13,89	106,57	18,0	220
PBA439(x/xx)-B150	15,7x19,7	250	7,61	6,28	13,89	177,04	45,0	441
PBA439(x/xx)-BC60	19,7x25,6	100	15,43	12,79	28,22	92,24	18,0	220
PBA439(x/xx)-BC150	19,7x25,6	250	15,43	127,87	143,30	157,86	45,0	551
PBA439(x/xx)-BC300	19,7x25,6	500	15,43	12,79	28,22	574,09	90,0	1102
PBA439(x/xx)-CC60	23,6x29,5	100	20,64	24,25	44,89	75,58	18,0	220
PBA439(x/xx)-CC150	23,6x29,5	250	20,64	24,25	44,89	256,27	45,0	551
PBA439(x/xx)-CC300	23,6x29,5	500	20,64	24,25	44,89	557,43	90,0	1102
PBA439(x/xx)-CC600	23,6x29,5	1000	25,35	31,09	56,44	597,03	180,0	1653



## 6.6 Zubehör

### Stativ

Artikel-Nr:	Bezeichnung	Beschreibung
72229393	Stativ offen 120 mm / 4,7"	Passend für alle Wägebrückengrößen
72198702	Stativ offen 330 mm / 13"	Passend für alle Wägebrückengrößen
72198703	Stativ offen 660 mm / 26"	Passend für alle Wägebrückengrößen
72198704	Stativ offen 900 mm / 35,4"	Passend für alle Wägebrückengrößen größer als Größe A

### Edelstahlwagen

Artikel-Nr:	Bezeichnung	Beschreibung
72225939	Edelstahlwagen BC	Passend für Wägebrücken der Größe BC
72225940	Edelstahlwagen CC	Passend für Wägebrücken der Größe CC

### Rollenbahn

Artikel-Nr:	Bezeichnung	Beschreibung
30253326	Rollenbahn 400 × 500 mm / 15,7" × 19,7" Edelstahl	Passend für Wägebrücken der Größe B. Rolle zur kurzen Seite der Wägebrücke
30253328	Rollenbahn 500 × 650 mm / 19,7" × 25,6" Edelstahl	Passend für Wägebrücken der Größe BC. Rolle zur kurzen Seite der Wägebrücke
30253330	Rollenbahn 600 × 800 mm / 23,6" × 31,5" Edelstahl	Passend für Wägebrücken der Größe CC. Rolle zur kurzen Seite der Wägebrücke
30253327	Rollenbahn 400 × 500 mm / 15,7" × 19,7" Edelstahl	Passend für Wägebrücken der Größe B. Rolle zur langen Seite der Wägebrücke
30253329	Rollenbahn 500 × 650 mm / 19,7" × 25,6" Edelstahl	Passend für Wägebrücken der Größe BC. Rolle zur langen Seite der Wägebrücke
30253331	Rollenbahn 600 × 800 mm / 23,6" × 31,5" Edelstahl	Passend für Wägebrücken der Größe CC. Rolle zur langen Seite der Wägebrücke
30640393	Rollenbahn 400 × 500 mm / 15,7" × 19,7" Edelstahl	Passend für explosionsgefährdete Bereiche
30640394	Rollenbahn 500 × 650 mm / 19,7" × 25,6" Edelstahl	Passend für explosionsgefährdete Bereiche
30640395	Rollenbahn 600 × 800 mm / 23,6" × 31,5" Edelstahl	Passend für explosionsgefährdete Bereiche

### Fronthalterung

Artikel-Nr:	Bezeichnung	Beschreibung
22021062	Fronthalterung	Passend für ICS4_9 Frontmontage

### Edelstahl-Wägeplatte

Artikel-Nr:	Bezeichnung	Beschreibung
30676769	AISI 316 Edelstahl-Wägeplatte 240 x 300 mm / 9,5" x 11,8"	Passend für Wägebrücken der Größe A
30676770	AISI 316 Edelstahl-Wägeplatte 300 x 400 mm / 11,8" x 15,7"	Passend für Wägebrücken der Größe BB
30676771	AISI 316 Edelstahl-Wägeplatte 400 x 500 mm / 15,7" x 19,7"	Passend für Wägebrücken der Größe B
30676772	AISI 316 Edelstahl-Wägeplatte 228 x 228 mm / 9" x 9"	Passend für Wägebrücken der Größe QA
30676773	AISI 316 Edelstahl-Wägeplatte 305 x 305 mm / 12" x 12"	Passend für Wägebrücken der Größe QB
30676774	AISI 316 Edelstahl-Wägeplatte 500 x 650 mm / 19,7" x 25,6"	Passend für Wägebrücken der Größe BC

Artikel-Nr:	Bezeichnung	Beschreibung
30676775	AISI 316 Edelstahl-Wägeplatte, Dicke 2,0 mm, 600 x 800 mm / 23,6" x 31,5"	Passend für Wägebrücken der Größe CC
30676776	AISI 316 Edelstahl-Wägeplatte, Dicke 2,5 mm, 600 x 800 mm / 23,6" x 31,5"	Passend für Wägebrücken der Größe CC

## 7 Montagemöglichkeiten

Das PBA439(x/xx) unterstützt die Montage auf einer stabilen Vorrichtung. Falls Bohrungen auf der Wägebrücke erforderlich sind, folgen Sie dem nachstehenden Bohrmuster.



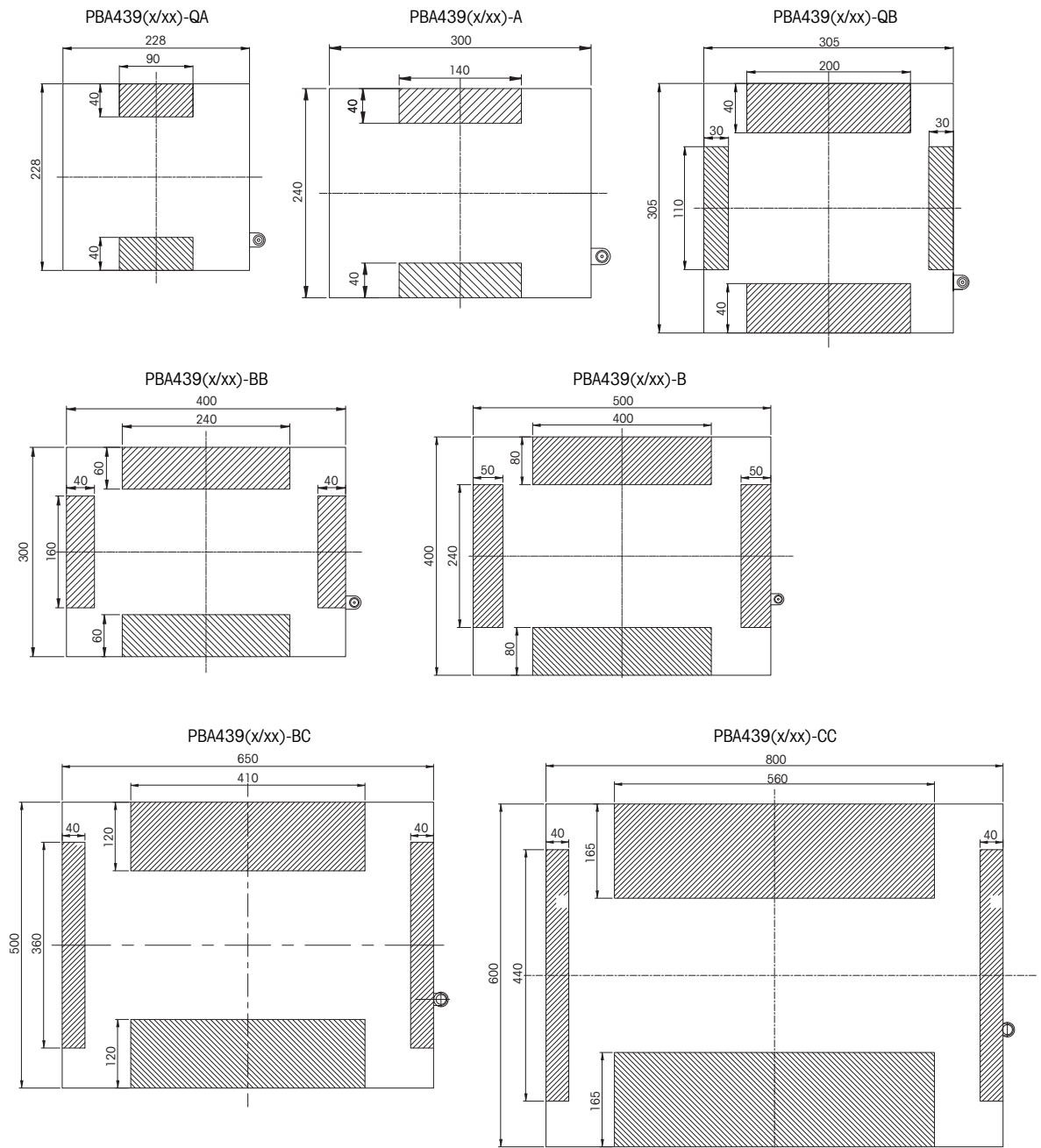

**HINWEIS: Die Schattengebiete sind die Bereiche, in denen Bohrungen auf der Wägebrücke erlaubt sind.**





Gemessen in [mm]



## 8 Anhang

### 8.1 Aufkleber

<p>IS CL I,II,III DIV 1, GP ABCDEFG T6...T4 Class I, Zone 1, AEx ia IIC T6...T4 Gb Class II,III, Zone 21, AEx ia IIIC T80°C Db -40°C ≤ Ta ≤ 60°C T5/T4; -40°C ≤ Ta ≤ 40°C T6 FM21US0076X</p> <hr/> <p>IS CL I,II,III DIV 1, GP ABCDEFG T6...T4 Class I, Zone 1, Ex ia IIC T6...T4 Gb Class II,III, Zone 21, Ex ia IIIC T80°C Db -40°C ≤ Ta ≤ 60°C T5/T4; -40°C ≤ Ta ≤ 40°C T6 FM21CA0051X</p>		  	<p>II 2G Ex ia IIC T6...T4 Gb II 2D Ex ia IIIC T80°C Db -40°C ≤ Ta ≤ 60°C T5/T4 -40°C ≤ Ta ≤ 40°C T6</p> <hr/> <p>Entity/NIFW for Nonincendive Field Wiring. Entity parameters are shown in drawing 30688074 Mettler-Toledo GmbH, Im Langacher 44, 8606 Greifensee, Switzerland</p>
---	---	---	---

<p>NI CL I,II,III DIV 2 GP ABCDFG T6 -40°C ≤ Ta ≤ 60°C FM21US0076X</p> <hr/> <p>NI CL I,II,III DIV 2 GP ABCDEFG T6...T4 -40°C ≤ Ta ≤ 60°C Class I, Zone 2, Ex ec IIC T6 Gc; Class II,III, Zone 22, Ex tc IIIC T80°C Dc FM21CA0051X</p>		  	<p>II 3G Ex ic IIC T6...T4 Gc -40°C ≤ Ta ≤ 60°C T5/T4 -40°C ≤ Ta ≤ 40°C T6</p> <hr/> <p>II 3G Ex ec IIC T6 Gc U-rated=20V II 3D Ex tc IIIC T80°C Dc I-rated=50mA -40°C ≤ Ta ≤ 60°C</p> <hr/> <p>Entity/NIFW for Nonincendive Field Wiring. Entity parameters are shown in drawing 30688074 Mettler-Toledo GmbH, Im Langacher 44, 8606 Greifensee, Switzerland</p>
--	---	---	---

## 8.2 Kontrollzeichnung

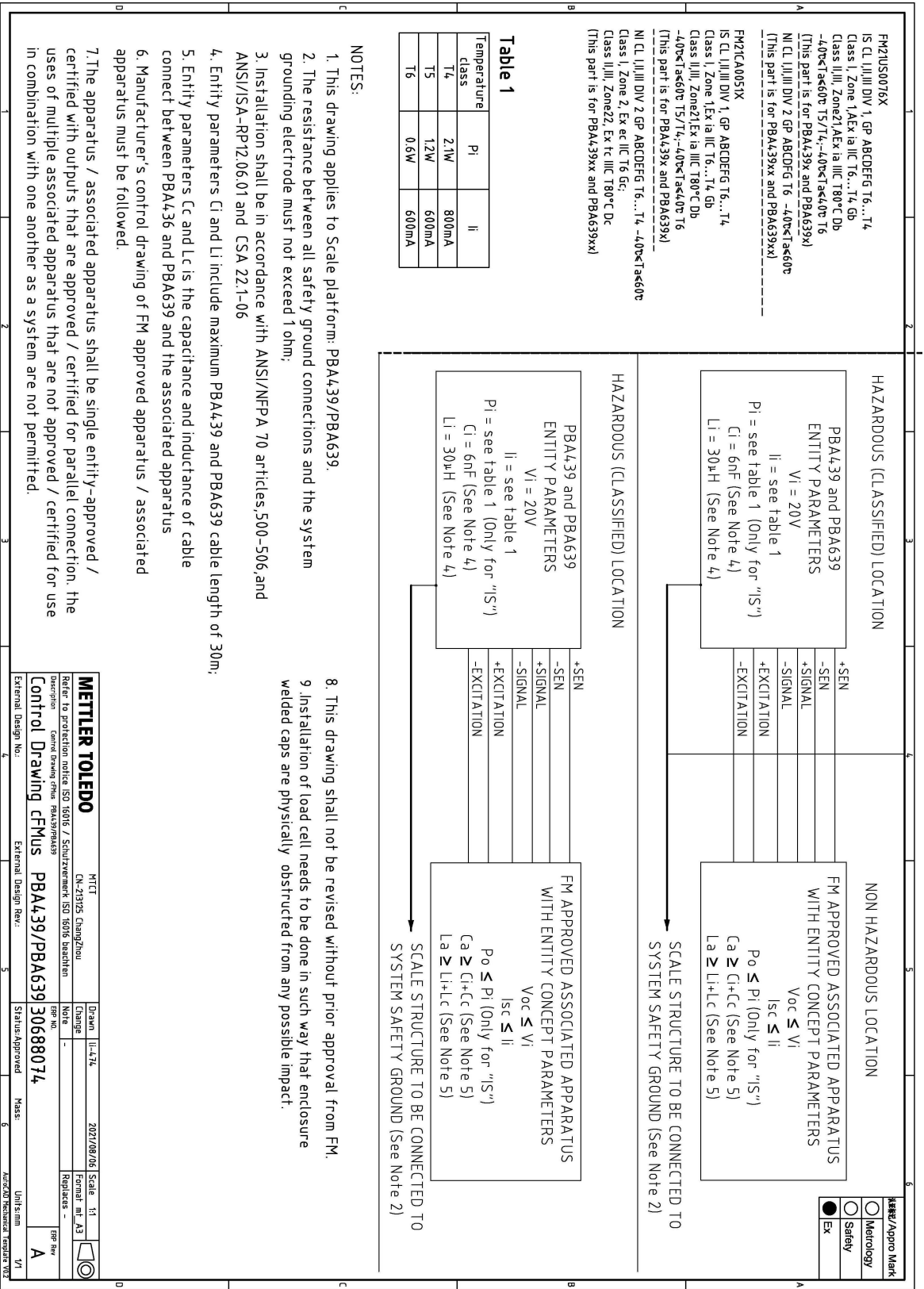

<b>METTLER TOLEDO</b>		MTC	Scale: II
Refer to protection notice ISO 10316 / Schutzvermerk ISO 10316 beachten		DN-23/25 Changzhou	Printed in A3
Description: Control Drawing CFMus		Part No: PBA439/PBA639	Replaces: -
External Design No: 30688074		Status: Approved	Part Rev: A
External Design Rev: 6		Mass: 6	Unit/Item: 1/1

### 8.3 Einbauzeichnung

#### Hazardous (Classified) Location

IP67 II 3G Ex ic IIC T6...T4 Gc  
-40°C≤Tas60°C T5/T4; -40°C≤Tas40°C T6

II 3G Ex ec IIC T6 Gc -40°C≤Tas60°C T6  
II 3D Ex tc IIIC T80°C Dc  
FM21UKEX0080X  
FM21ATEX0025X IECEX FMG21.0003X

---

II 2G Ex ia IIC T6...T4 Gb  
-40°C≤Tas60°C T5/T4; -40°C≤Tas40°C T6

II 2D Ex ia IIIC T80°C Db  
FM21UKEX0079X  
FM21ATEX0003X IECEX FMG21.0003X

Approval Mark

THIS ITEM IS PART OF AGENCY APPROVED PRODUCT

Metrology  
 Safety  
 Ex

DO NOT CHANGE DOCUMENT WITHOUT APPROPRIATE APPROVAL

SLP84x Load Cell

U<sub>i</sub> = 20V  
l<sub>i</sub> = see table2  
P<sub>i</sub> = see table 2  
C<sub>i</sub> = 6nF  
L<sub>i</sub> = 30uH

+Excitation(Green)

-Excitation(Black)

+SEN(Yellow)

-SEN(Blue)

+Signal(White)

-Signal(Red)

Ex Approved Associated Apparatus with Entity Concept Parameters

U<sub>o</sub> ≤ U<sub>i</sub>  
I<sub>o</sub> ≤ I<sub>i</sub>  
P<sub>o</sub> ≤ P<sub>i</sub>  
C<sub>o</sub> ≥ C<sub>c</sub>+C<sub>i</sub>  
L<sub>o</sub> ≥ L<sub>c</sub>+L<sub>i</sub>

Scale structure (attached to load cell) to be connected to system safety ground. See Note.

**NOTES:**

- 1.The resistance between all safety ground connections and the system grounding electrode must not exceed 1ohm.
- 2.Installation shall be in accordance with relevant electrical installation standards (Being shown in Table 1)in hazardous areas(other than mines).
- 3.Entity Parameters C<sub>i</sub> And L<sub>i</sub> Include Maximum Load Cell Cable Length Of 30m
- 4.Entity Parameters C<sub>c</sub> and L<sub>c</sub> is the capacitance and inductance of cable connect between load cell and the associated apparatus.
- 5.In an explosive atmosphere caused by air/dust mistures, the loose ends of the cable shall be connected outside the hazardous area or in a suitable enclosure with a degree of protection of at least IP6X in accordance with EN 60529.
- 6.For the application of Ex ec, Ex tc: U<sub>rated</sub>=20V,I<sub>rated</sub>=50mA.
- 7.Installation of load cell needs to be done in such way that enclosure welded caps are physically obstructed from any possible impact.
8. ⚠ Not following these instructions will jeopardize the explosion safety.
9. For the application of Ex ec, The equipment shall only be used in an area of at least pollution degree 2, as defined in IEC 60664-1.

Table 1

EN60079-0: 2018	EN60079-14: 2014	EN60079-11: 2012	EN60079-31: 2014
EN61241-14: 2004	EN60079-31: 2013	EN60079-7: 2015	IEC60079-31: 2013
IEC 60079-0-2017	IEC 60079-11-2011	IEC 60079-14-2013	IEC60079-7: 2015

Table 2

Temperature class	P <sub>i</sub>	l <sub>i</sub>
T4	2.1W	800mA
T5	1.2W	600mA
T6	0.6W	600mA

Mettler-Toledo GmbH, Im Langacher 44, 8606 Greifensee, Switzerland  
Mettler-Toledo Ltd. 64 Boston Rd.Leicester, LE4 1AW, United Kingdom

D	update drawing status	Wang Jianwen	Liu Yuchun		2021-7-26
C	removed Ex nA of note6	Wang Jianwen	Liu Yuchun		2021-1-15
REV / CHG	DESCRIPTION	BY	APPVD	AGENCY	E.R. No. DATE
RECORD OF CHANGES					
<b>METTLER TOLEDO</b>		MTCZ	Drawn Wang JW	2020/05/11	Scale 1:1
		CN-213022 ChangZhou	Change		Format mt_A4
Refer to protection notice ISO 16016 / Schutzvermerk ISO 16016 beachten		Note	-		Replaces -
Description 防爆安装图 SLP84X		ERP NO.	30555321		ERP Rev
<b>INSTALLATION DRAWING SLP84X ATEX/IECEX</b>					<b>D</b>
External Design No.:D000644580		External Design Rev.:D		Status:Approved	Mass: Units:mm 1/1

AutoCAD Mechanical Template V0.2

# METTLER TOLEDO Service

Nous vous félicitons d'avoir choisi la qualité et la précision de METTLER TOLEDO. L'utilisation appropriée de votre nouvel équipement conformément aux instructions de ce mode d'emploi, ainsi que l'étalonnage et l'entretien régulier par notre équipe de techniciens de maintenance formés en usine, garantissent un fonctionnement fiable et précis, tout en assurant la protection de votre investissement. Contactez-nous pour recevoir un contrat de maintenance adapté à vos besoins et à votre budget. Pour plus d'informations, visitez notre site ► [www.mt.com/service](http://www.mt.com/service).

Il y a plusieurs façons importantes d'optimiser les performances de votre investissement :

- 1 **Enregistrer votre produit** : nous vous invitons à enregistrer votre produit sur [www.mt.com/productregistration](http://www.mt.com/productregistration) afin que nous puissions vous contacter au sujet des améliorations, des mises à jour et des notifications importantes concernant votre produit.
- 2 **Contactez METTLER TOLEDO pour la maintenance** : la valeur d'une mesure est proportionnelle à sa précision. Une balance produisant des résultats hors spécifications peut entraîner une perte de qualité, une diminution des profits et un accroissement des risques liés à la responsabilité. La maintenance en temps opportun de METTLER TOLEDO garantit la précision et permet d'optimiser le temps de fonctionnement et la durée de vie de l'équipement.
  - ➔ **Installation, Configuration, Intégration et Formation** : nos techniciens de maintenance sont des experts des équipements de pesage formés en usine. Tout en demeurant abordables, nous veillons à préparer rapidement vos équipements de pesage pour la production et à former votre personnel pour garantir la bonne utilisation des équipements.
  - ➔ **Documentation sur l'étalonnage initial** : les exigences afférentes à l'environnement d'installation et à l'application étant propres à chaque balance industrielle, les performances font l'objet de tests et d'une certification. Nos services d'étalonnage et nos certificats documentent l'exactitude pour garantir la qualité de la production et fournir un archivage de la qualité des performances du système.
  - ➔ **Étalonnage périodique et maintenance** : un contrat de maintenance spécifique à l'étalonnage vous permet d'avoir toute confiance dans vos procédés de pesage et dans la conformité de votre documentation aux normes en vigueur. Nous proposons de nombreux plans de maintenance conçus pour répondre à vos besoins et s'adapter à votre budget.





# Table des matières

<b>1</b>	<b>Consignes de sécurité</b>	<b>3</b>
1.1	Destination conforme .....	3
1.2	Usage abusif .....	3
1.3	Précautions de sécurité.....	3
1.4	Conditions particulières d'utilisation .....	4
<b>2</b>	<b>Introduction</b>	<b>5</b>
2.1	Assortiment .....	5
2.2	À propos de ce manuel.....	5
2.3	Autres documents .....	5
<b>3</b>	<b>Installation et fonctionnement</b>	<b>6</b>
3.1	Branchez la plate-forme de pesage au terminal de pesage .....	6
3.2	Mise à niveau.....	7
3.3	Liaison équipotentielle .....	7
3.4	Contrôle de la plate-forme de pesage .....	7
3.5	Fonctionnement de la plate-forme de pesage .....	8
3.6	Installation, configuration, service après-vente et réparation.....	8
<b>4</b>	<b>Maintenance</b>	<b>9</b>
4.1	Notes sur le nettoyage .....	9
4.2	Traitement subséquent.....	9
4.3	Mise au rebut .....	10
<b>5</b>	<b>Réparation</b>	<b>11</b>
<b>6</b>	<b>Caractéristiques techniques et limites de fonctionnement</b>	<b>12</b>
6.1	Intervalle maximum de balance vérifiée .....	12
6.2	Charge maximale admissible .....	12
6.3	Caractéristiques techniques du capteur de charge.....	13
6.3.1	Homologation Ex .....	13
6.3.2	Norme de conformité des capteurs de charge .....	13
6.4	Dimensions.....	15
6.5	Indications concernant la capacité et la charge préalable .....	16
6.5.1	Tableau de charge préalable en kilos .....	17
6.5.2	Tableau de charge préalable en livres.....	18
6.6	Accessoires.....	19
<b>7</b>	<b>Possibilités de montage</b>	<b>21</b>
<b>8</b>	<b>Annexe</b>	<b>22</b>
8.1	Étiquette.....	22
8.2	Plan de contrôle .....	23
8.3	Dessin d'installation.....	24



# 1 Consignes de sécurité

## 1.1 Destination conforme

PBA439(x/xx) de plates-formes de pesage font partie d'un système de pesage modulaire constitué d'un terminal de pesage METTLER TOLEDO comme afficheur et d'au moins une plate-forme de pesage.

- Utilisez la plate-forme de pesage uniquement pour le pesage conformément à ce manuel.
- La plate-forme de pesage est destinée à un usage intérieur uniquement.
- Seul le PBA439x/xx de plate-forme de pesage convient pour l'utilisation dans un environnement dangereux tel que spécifié ci-dessous.
- Tout autre type d'utilisation est considéré comme non conforme.

### Métrologie légale

- Pour l'utilisation en métrologie légale, utilisez uniquement des plates-formes de pesage homologuées.
- Lors de l'utilisation en métrologie légale, l'entreprise d'exploitation est responsable du respect de toutes les exigences nationales de poids & mesures.
- Veuillez contacter le service après-vente METTLER TOLEDO pour les questions relatives aux applications légales pour le commerce.

## 1.2 Usage abusif

- N'utilisez pas le terminal de pesage pour autre chose que peser des marchandises.
- N'utilisez pas la plate-forme de pesage dans un environnement autre que celui spécifié au point --- MISSING LINK ---.
- Ne modifiez pas la plate-forme de pesage.
- N'utilisez pas le terminal de pesage au-delà des limites des spécifications techniques.
- N'utilisez pas la plate-forme de pesage pour stocker des marchandises.
- Évitez de laisser tomber des marchandises sur la plate-forme de pesage.

## 1.3 Précautions de sécurité

- Seul du personnel formé et qualifié par METTLER TOLEDO peut installer et entretenir la plate-forme de pesage.
- Soyez prudent lors du transport ou du levage de lourdes charges.
- Déconnectez toujours la plate-forme de pesage de la source d'alimentation avant de l'installer, de la régler, de la nettoyer ou d'en faire la maintenance.
- Le câble de connexion ne doit pas être déconnecté du terminal de pesage lorsque celui-ci est mis sous énergie.
- Vérifiez que la plate-forme de pesage a atteint la température ambiante avant d'enclencher l'alimentation électrique.
- Les plates-formes de pesage protégées contre l'explosion PBA439x/xx sont homologuées pour le fonctionnement dans les zones dangereuses suivantes:
  - ATEX/IECEx catégorie 2, catégorie 3, gaz/poussière (zone 1/21, zone 2/22)
  - cFMus, classe I,II,III, div. 1, div. 2
- Il y a un risque accru de blessure et de dommage si les plates-formes de pesage sont utilisées dans des zones dangereuses ! Un soin spécial doit être apporté lors du travail dans de telles zones.
- Dans le cas de la plate-forme de pesage PBA439x/xx, utilisez uniquement des traversées de câbles appropriées et homologuées pour les zones dangereuses pour l'insertion du câble du capteur de charge dans le terminal de pesage.
- Les plates-formes de pesage protégées contre les explosions peuvent uniquement être utilisées dans des zones dangereuses en conjonction avec des terminaux de pesage qui disposent de l'homologation et de la spécification d'interface appropriées.

## 1.4 Conditions particulières d'utilisation

- Dans une atmosphère explosive due à l'humidité de l'air/de la poussière, les extrémités libres du câble doivent être connectées à l'extérieur de la zone dangereuse ou dans une enceinte appropriée avec un degré de protection d'au moins IP6X conformément à la norme IEC/EN 60529.

## 2 Introduction

### 2.1 Assortiment

Ce manuel se concentre sur la série de produits PBA439(x/xx).

La série PBA439(x/xx) propose une variété de plates-formes de pesage pour répondre à vos besoins. Elle est homologable et disponible en diverses tailles et capacités

Type	Matériau du plateau de charge	Matériau du cadre de la balance	Design du capteur de charge	Protection IP environnementale	Homologation pour zone dangereuse
PBA439	Acier inoxydable AISI304	Acier inoxydable AISI304	Acier inoxydable, hermétiquement fermé	Sec, mouillé, IP68/IP69K	-
PBA439x					Zones 1/21, div. 1
PBA439xx					Zones 2/22, div. 2

### 2.2 À propos de ce manuel



Ce manuel contient toutes les informations destinées à l'opérateur du produit.

- Lisez ce manuel attentivement avant utilisation.
- Conservez ce manuel pour toute référence ultérieure.
- Transmettez ce document à tout propriétaire ou utilisateur ultérieur du produit.

### 2.3 Autres documents

En plus de ce manuel, vous pouvez télécharger les documents suivants sur ► [www.mt.com](http://www.mt.com) :

- Brochure
- Informations sur l'installation (pour le personnel formé sous la supervision de la société d'exploitation)
- Documents d'approbation de type

#### Téléchargement de certificats

Les certificats américains, canadiens, ATEX, UKEX et IECEx peuvent être téléchargés sur le site :

► <https://www.mt.com/us/en/home/search/compliance.html/compliance/>.

### 3 Installation et fonctionnement

#### 3.1 Branchez la plate-forme de pesage au terminal de pesage

Les plates-formes de pesage PBA439(x/xx) sont conçues pour l'utilisation avec des terminaux de pesage analogiques METTLER TOLEDO.

- 1 Insérez le câble de la plate-forme de pesage via la traversée de câble dans le terminal de pesage.
- 2 Connectez le câble de la plate-forme de pesage à la bande terminale du terminal de pesage suivant le tableau suivant.

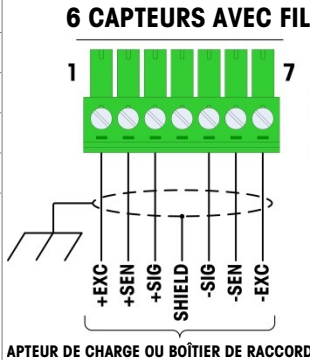
Signal	Couleur du fil	Connecteur
SIG+	Blanc	
SIG-	Rouge	
EXC+	Vert	
EXC-	Noir	
SEN+	Jaune	
SEN-	Bleu	



#### **AVERTISSEMENT**

**Le blindage du câble doit être mis à la terre.**

#### Précautions de sécurité pour les connexions

- Lors de la connexion de la plate-forme de pesage dans une zone dangereuse, respectez strictement les exigences indiquées dans le schéma de contrôle disponible en [Annexe ► page 22].
- Veuillez vérifier les conditions spéciales pour une utilisation sûre dans les schémas et les certificats en [Annexe ► page 22].
- Le blindage du câble est connecté à l'élément de ressort du capteur de charge (le corps du capteur de charge). Veuillez considérer la connexion appropriée entre le capteur de charge et le terminal (ou le boîtier de raccordement) en fonction du scénario d'installation.
- La résistance entre toutes les connexions de mise à la terre et l'électrode de mise à la terre du système ne doit pas dépasser 1 ohm.
- L'installation doit être conforme aux normes d'installation électrique en vigueur.
- Le non-respect de ces instructions peut compromettre la sécurité de l'explosion.

## 3.2 Mise à niveau

Seule une plate-forme de pesage qui est alignée exactement à l'horizontale fournit des résultats de pesage exacts. La plate-forme de pesage doit être mise à niveau durant l'installation initiale et chaque fois que son emplacement est modifié.

- 1 Tournez les pieds réglables de la plate-forme de pesage jusqu'à ce que la bulle d'air du niveau à bulle d'air soit positionnée dans le cercle intérieur.
- 2 Serrez les contre-écrous des pieds réglables.

 Pour regarder la vidéo, scannez le code QR

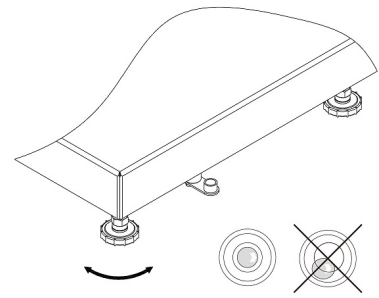

## 3.3 Liaison équipotentielle

La liaison équipotentielle pour les plates-formes de pesage PBA439x/xx est montée en usine. Le câblage doit être installé par un électricien professionnel sur le site du client. Le service après-vente METTLER TOLEDO a ici uniquement une fonction de surveillance et de consultation. Connectez la liaison équipotentielle (PA) de tous les dispositifs (plate-forme de pesage et terminal de pesage) conformément aux réglementations et normes spécifiques au pays. Ce faisant, vérifiez que tous les boîtiers d'appareils sont connectés au même potentiel via la borne PA.

### Note

L'équipement est protégé contre les chocs électriques selon IEC60950, classe II.

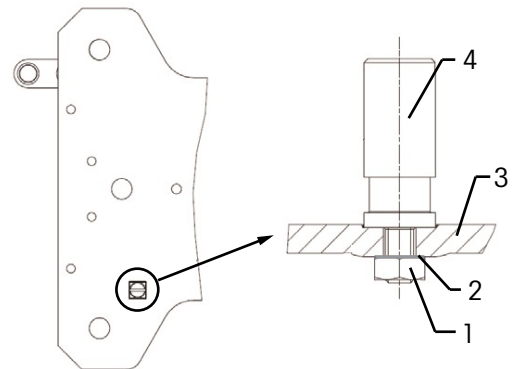

- 1 - Contre-écrou hexagonal, M4 KEPS
- 2 - Rondelle
- 3 - Cadre de base
- 4 - Borne de liaison équipotentielle, couple de serrage 3,5 Nm

Numéro de commande du kit de liaison équipotentielle 72237321

## 3.4 Contrôle de la plate-forme de pesage

### Contrôle du fonctionnement

- 1 Vérifiez que la plate-forme de pesage est connectée à un terminal de pesage et que le terminal de pesage est enclenché.
- 2 Vérifiez que la plate-forme de pesage est déchargée et que l'afficheur du terminal de pesage indique 0.
- 3 Chargez la plate-forme de pesage. Le terminal de pesage doit indiquer une valeur différente de 0.
- 4 Déchargez la plate-forme de pesage. Le terminal de pesage doit revenir à 0.

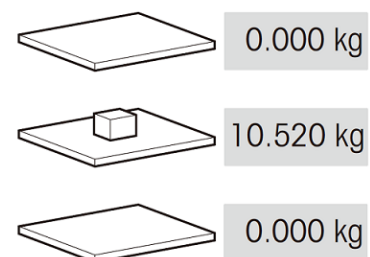

### Test de vérification

Pour un test de vérification, consultez le manuel de l'utilisateur du terminal de pesage connecté. Si le sceau de vérification est brisé, la vérification n'est plus valable.

### 3.5 Fonctionnement de la plate-forme de pesage

Pour obtenir les meilleurs résultats de pesage possibles, respectez ce qui suit :

- Assurez-vous que le plateau de chargement soit correctement placé.

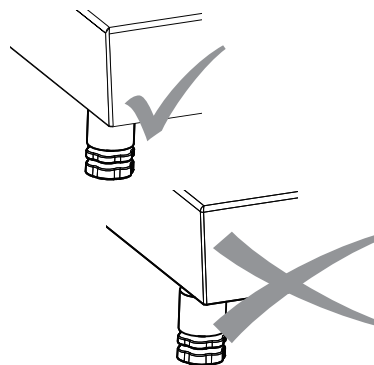

- Afin d'obtenir les meilleurs résultats de pesage, placez toujours la marchandise à peser dans la même position sur la plate-forme de pesage.

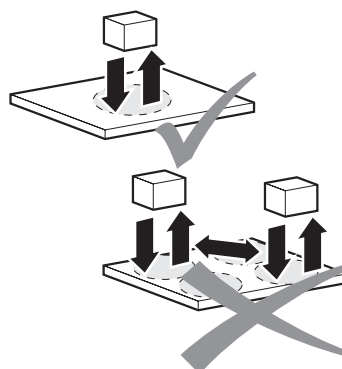

- Évitez les processus d'abrasion et d'usure.

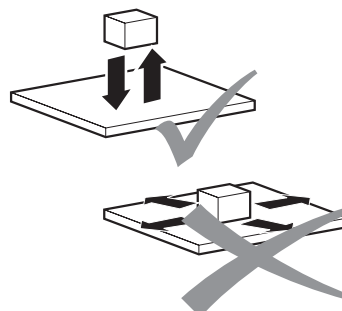

- Évitez de laisser tomber les charges, les chocs et les impacts latéraux.

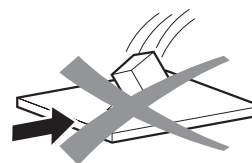

### 3.6 Installation, configuration, service après-vente et réparation

Pour l'installation, la configuration, le service après-vente et la réparation des plates-formes de pesage, appelez le service après-vente METTLER TOLEDO.



## 4 Maintenance

### 4.1 Notes sur le nettoyage

#### Remarque

##### Dompage à la plate-forme de pesage suite à l'utilisation incorrecte des produits de nettoyage.

- Utilisez uniquement des désinfectants et produits de nettoyage conformes aux instructions de leur fabricant.
- N'utilisez pas de produits de nettoyage fortement acides, fortement alcalins ou fortement chlorés. Évitez les substances avec un pH élevé ou bas, vu qu'elles présentent un danger accru de corrosion.
- Soyez particulièrement prudent lors du nettoyage du capteur de charge.

#### Procédure de nettoyage

- Retirez la saleté et les dépôts à intervalles réguliers de l'extérieur et de l'intérieur de la plate-forme de pesage.
  - ➔ La procédure dépend du type de surface et des conditions d'environnement régnant à l'emplacement d'installation.

#### Nettoyage dans un environnement humide (version acier inoxydable)

- Utilisez un jet d'eau à max. 80 °C / 176 °F et max. 80 bars, distance minimale 40 cm / 16".
- Utilisez des produits de nettoyage de ménage.

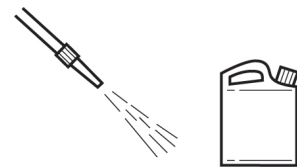

#### Nettoyage dans un environnement corrosif (versions acier inoxydable)

- Utilisez un jet d'eau.  
**Nettoyage intérieur**, capteur de charge, plaque de charge ouverte : jusqu'à 60 °C / 140 °F et max. 2 bars, distance minimale 40 cm / 16".

**Nettoyage extérieur**, plateau de charge fermé : jusqu'à 80 °C / 176 °F et max. 80 bars, distance minimale 40 cm / 16".

- Retirez les substances corrosives à intervalles réguliers.
- Utilisez uniquement des désinfectants et produits de nettoyage en conformité avec les spécifications et instructions de leur fabricant

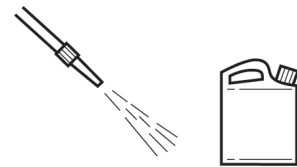

### 4.2 Traitement subséquent

Afin de protéger la balance, exécutez le traitement subséquent suivant :

- Rincez la balance à l'eau claire et éliminez complètement le produit de nettoyage.
- Séchez la balance avec un chiffon non peluchant.
- Traitez l'intérieur et l'extérieur des balances en acier inoxydable avec une huile appropriée pour les produits alimentaires.

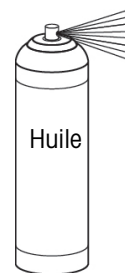

### 4.3 Mise au rebut

Conformément à la directive européenne 2012/19/CE relative à la mise au rebut des équipements électriques et électroniques (WEEE), ce dispositif ne doit pas être jeté avec les déchets ménagers. Logiquement, ceci est aussi valable pour les pays en dehors de l'UE conformément aux réglementations nationales en vigueur.

Veillez éliminer cet appareil conformément aux prescriptions locales dans un conteneur séparé pour appareils électriques et électroniques. Pour toute question, adressez-vous aux autorités compétentes ou au revendeur chez qui vous avez acheté cet appareil. En cas de transmission de ce dispositif à des tiers, le contenu de cette réglementation doit également être joint.



## 5 Réparation

Cet équipement est certifié pour une utilisation dans des endroits dangereux, par conséquent aucune modification n'est autorisée. Les réparations ne doivent être effectuées que par du personnel spécifiquement formé aux réparations de cet équipement.

## 6 Caractéristiques techniques et limites de fonctionnement

### 6.1 Intervalle maximum de balance vérifiée

Intervalle maximum de balance vérifiée [e] / OIML	Capacité							
	3 kg	6 kg	15 kg	30 kg	60 kg	150 kg	300 kg	600 kg
1 x 3000e Max / e [kg]	3 / 0.001	6 / 0.002	15 / 0.005	30 / 0.01	60 / 0.02	150 / 0.05	300 / 0.1	600 / 0.2

Intervalle maximum de balance vérifiée [d] / NTEP	Capacité							
	-	10 lb	25 lb	50 lb	100 lb	250 lb	500 lb	1000 lb
1 x 5000d Max / d [lb]	-	10 / 0.002	25 / 0.005	50 / 0.01	100 / 0.02	250 / 0.05	500 / 0.1	1000 / 0.2

### 6.2 Charge maximale admissible

Toutes les plates-formes de pesage sont équipées d'une protection contre la surcharge. Avec la conception robuste de la balance, vous pouvez occasionnellement dépasser la capacité nominale de la plate-forme sans dommage. La charge statique sans danger maximale ne doit jamais être dépassée.

- Observez les limites de fonctionnement suivantes.

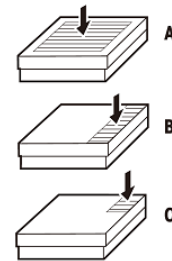

Modèle	A - Charge centrée	B - Charge latérale	C - Charge excentrée
PBA439(x/xx)-QA	40 kg / 80 lb	30 kg / 60 lb	15 kg / 30 lb
PBA439(x/xx)-A	40 kg / 80 lb	30 kg / 60 lb	15 kg / 30 lb
PBA439(x/xx)-QB	100 kg / 200 lb	70 kg / 140 lb	35 kg / 70 lb
PBA439(x/xx)-BB	100 kg / 200 lb	70 kg / 140 lb	35 kg / 70 lb
PBA439(x/xx)-B	200 kg / 400 lb	140 kg / 280 lb	75 kg / 150 lb
PBA439(x/xx)-BC	400 kg / 800 lb	300 kg / 600 lb	150 kg / 300 lb
PBA439(x/xx)-CC	700 kg / 1400 lb	400 kg / 800 lb	200 kg / 400 lb



#### **AVERTISSEMENT**

**Évitez de laisser tomber des charges, évitez les chocs ainsi que les impacts latéraux.**

## 6.3 Caractéristiques techniques du capteur de charge

Sortie nominale	mV/V	1,8 ± 0,2
Résistance d'entrée	Ω	384 ± 15
Résistance de sortie	Ω	350 ± 4
Tension recommandée	V (DC / AC)	5 - 15
Tension excitée max.	V (DC / AC)	20
Gaine du câble	-	PVC
Classification IP	-	IP68/IP69K

### 6.3.1 Homologation Ex

Cette section ne couvre que les aspects Ex du produit.

Le capteur de charge SLP84x(x=6,7,8) a reçu :

Certificat ATEX	FM21ATEX0003X, FM21ATEX0025X
Certificat UK	FM21UKEX0079X, FM21UKEX0080X
Certificat IECEx	IECEx FMG21.0003X
Certificat US	FM21US0005X
Certificat canadien	FM21CA0002X

Les certificats énumérés ci-dessus et les schémas d'installation correspondants sont présentés en [Annexe ► page 22].

### 6.3.2 Norme de conformité des capteurs de charge

#### Normes US

Titre	Numéro	Date de publication
Équipement électrique pour l'utilisation dans des zones dangereuses (classifiées) – Exigences générales	FM Classe 3600	2018
Appareil et appareil associé à sécurité intrinsèque pour l'utilisation dans des zones dangereuses (classifiées) classes I, II, & III, division 1.	FM Classe 3610	2021
Matériel électrique non incendiaire à utiliser en classe I et II, division 2 et classe III, divisions 1 et 2, zones dangereuses (classifiées)	FM Classe 3611	2021
Équipement électrique pour la mesure, la commande et l'utilisation en laboratoire	FM Classe 3810	2021
Atmosphères explosives - Partie 0 : Équipement - Exigences générales	ANSI/UL 60079-0	2019
Atmosphères explosives – Partie 11 : Protection de l'équipement par sécurité intrinsèque "i"	ANSI/UL 60079- 11	2014
Matériel électrique non incendiaire à utiliser en classe I et II, division 2 et classe III, divisions 1 et 2, zones dangereuses (classifiées)	ANSI/UL 121201	2017
Exigences de sécurité pour équipement électrique pour la mesure, la commande et l'utilisation en laboratoire – Partie 1 : Exigences générales	ANSI/UL 61010-1	2012
Degrés de protection fournis par les enceintes (code IP)	ANSI/IEC 60529	2020

#### Normes canadiennes

Titre	Numéro	Date de publication
Matériel électrique non incendiaire pour utilisation dans les zones dangereuses de classe I, division 2	CSA C22.2 No. 213	2017
Atmosphères explosives - Partie 0 : Équipement - Exigences générales	CAN/CSA-C22.2 No. 60079-0	2019
Atmosphères explosives - Partie 11 : Protection de l'équipement par sécurité intrinsèque "i"	CAN/CSA-C22.2 No. 60079-11	2014

Titre	Numéro	Date de publication
Atmosphères explosives - Partie 7 : Protection de l'équipement par sécurité intrinsèque "e"	CAN/CSA-C22.2 No. 60079-7	2018
Atmosphères explosives - Partie 31 : Protection du matériel contre l'inflammation des poussières par enceinte "t".	CAN/CSA-C22.2 No. 60079-31	2015
Exigences de sécurité pour équipement électrique pour la mesure, la commande et l'utilisation en laboratoire – Partie 1 : Exigences générales	CSA C22.2 No. 61010-1	2012
Degrés de protection fournis par les enceintes (code IP)	CSA C22.2 No. 60529	2016

### Normes IECEx

Titre	Numéro	Date de publication
Atmosphères explosives - Partie 0 : Équipement - Exigences générales	IEC 60079-0	2017
Atmosphères explosives - Partie 11 : Protection de l'équipement par sécurité intrinsèque "i"	IEC 60079-11	2011
Atmosphères explosives - Partie 7 : Protection de l'équipement par sécurité intrinsèque "e"	IEC 60079-7	2017
Atmosphères explosives - Partie 31 : Protection du matériel contre l'inflammation des poussières par enceinte "t".	IEC 60079-31	2013
Degrés de protection fournis par les enceintes (code IP)	IEC 60529	2013

### Normes ATEX

Titre	Numéro	Date de publication
Atmosphères explosives - Partie 0 : Équipement - Exigences générales	EN IEC 60079-0	2018
Atmosphères explosives - Partie 11 : Protection de l'équipement par sécurité intrinsèque "i"	EN 60079-11	2012
Atmosphères explosives - Partie 7 : Protection de l'équipement par sécurité intrinsèque "e"	EN 60079-7	2015 +A1:2018
Atmosphères explosives - Partie 31 : Protection du matériel contre l'inflammation des poussières par enceinte "t".	EN 60079-31	2014
Degrés de protection fournis par les enceintes (code IP)	EN 60529	1991 + A1:2000 + A2:2013

### Normes UKEX

Titre	Numéro	Date de publication
Atmosphères explosives - Partie 0 : Équipement - Exigences générales	EN IEC 60079-0	2018
Atmosphères explosives - Partie 11 : Protection de l'équipement par sécurité intrinsèque "i"	EN 60079-11	2012
Atmosphères explosives - Partie 7 : Protection de l'équipement par sécurité intrinsèque "e"	EN 60079-7	2015 +A1:2018
Atmosphères explosives - Partie 31 : Protection du matériel contre l'inflammation des poussières par enceinte "t".	EN 60079-31	2014
Degrés de protection fournis par les enceintes (code IP)	EN 60529	1991 + A1:2000 + A2:2013

## 6.4 Dimensions

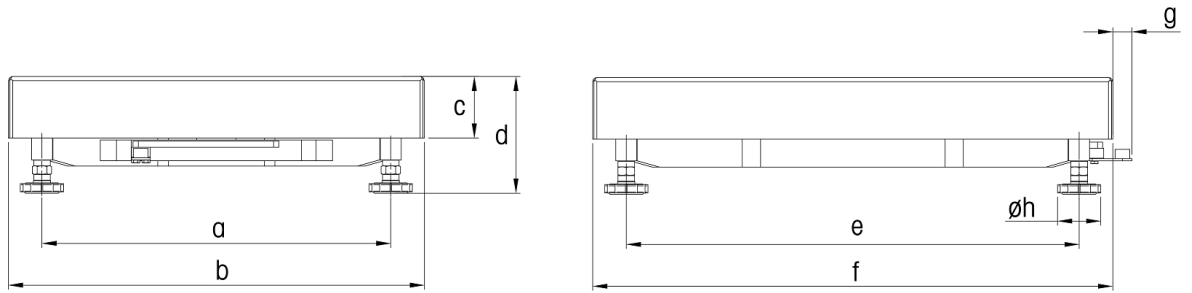

Dimensions		a	b	c	d *	e	f	g	h
PBA439(x/xx)-QA	mm	163	228	56	85,6	163	228	21	42
	pouces	6,42	8,98	2,20	3,37	6,42	8,98	0,83	1,65
PBA439(x/xx)-A	mm	175	240	56	85,6	235	300	21	42
	pouces	6,89	9,45	2,20	3,37	9,25	11,81	0,83	1,65
PBA439(x/xx)-QB	mm	240	305	57	96,6	253	305	18	42
	pouces	9,45	12,01	2,24	3,8	9,96	12,01	0,71	1,65
PBA439(x/xx)-BB	mm	235	300	57	96,6	335	400	18	42
	pouces	9,25	11,81	2,24	3,8	13,19	15,75	0,71	1,65
PBA439(x/xx)-B	mm	335	400	59	100,1	435	500	18	42
	pouces	13,19	15,75	2,32	3,94	17,13	19,69	0,71	1,65
PBA439(x/xx)-BC	mm	437	500	73	106,8	584	650	17	42
	pouces	17,20	19,69	2,87	4,2	22,99	25,59	0,67	1,65
PBA439(x/xx)-CC	mm	503	600	85	128,3	724	800	18	42
	pouces	19,80	23,62	3,35	5,05	28,5	31,50	0,71	1,65

\* : 1) d= hauteur minimale de la plate-forme. Avec les pieds réglables de la balance, la hauteur de la plate-forme peut augmenter de 10 mm / 0,39 pouce au maximum.

2) Avec le kit d'hygiène optionnel, la hauteur de la plate-forme (d) augmente de 12 mm / 0,47 pouce.

## 6.5 Indications concernant la capacité et la charge préalable

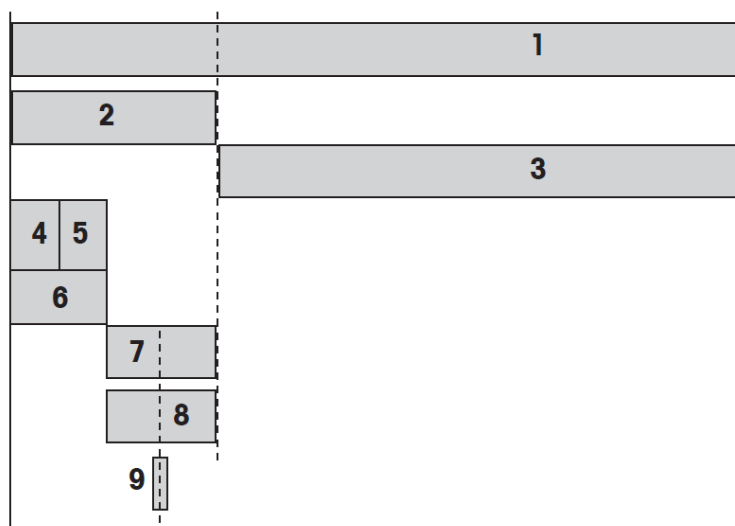

<b>1</b>	Plage maximale de charge du capteur de charge ( $E_{max}$ )
<b>2</b>	Charge préalable maximale = Plage de charge maximale <b>1</b> – Charge maximale <b>3</b>
<b>3</b>	Charge maximale = Plage de charge maximale <b>1</b> – Charge préalable maximale <b>2</b>
<b>4</b>	Charge préalable partie supérieure
<b>5</b>	Charge préalable plateau
<b>6</b>	Charge préalable sortie usine = Charge préalable partie supérieure <b>4</b> + Charge préalable plateau <b>5</b>
<b>7</b>	Réserve de charge préalable mécanique = Charge préalable maximale <b>2</b> – Charge préalable sortie usine <b>6</b>
<b>8</b>	La plage de définition de zéro (à l'enclenchement,) peut être réglée. La plage de définition de zéro doit se situer dans les limites de la charge préalable maximale. La plage de définition de zéro peut être max. 18 % de la charge maximale.
<b>9</b>	Plage de définition de zéro $\pm 2$ % de la charge maximale



## 6.5.1 Tableau de charge préalable en kilos

Type	Dimensions [mm]	Charge max. (3)	Charge préalable partie sup. (4)	Charge préalable plateau de pesage (5)	Charge préalable sortie usine (6)	Réserve mécanique de charge préalable (7)	Plage de définition de zéro (8)	Plage de charge max. (1)
PBA439(x/xx)-QA3	228x228	3	1,04	0,95	1,99	6,01	0,54	11
PBA439(x/xx)-QA6	228x228	6	1,04	0,95	1,99	3,01	1,08	11
PBA439(x/xx)-A3	240x300	3	1,49	1,23	2,72	5,28	0,54	11
PBA439(x/xx)-A6	240x300	6	1,49	1,23	2,72	2,28	1,08	11
PBA439(x/xx)-A15	240x300	15	1,49	1,23	2,72	4,28	2,70	22
PBA439(x/xx)-QB15	305x305	15	1,70	1,51	3,21	3,79	2,70	22
PBA439(x/xx)-QB30	305x305	30	1,70	1,51	3,21	16,79	5,40	50
PBA439(x/xx)-QB60	305x305	60	1,70	1,51	3,21	36,79	10,80	100
PBA439(x/xx)-BB30	300x400	30	2,08	1,86	3,94	16,06	5,40	50
PBA439(x/xx)-BB60	300x400	60	2,08	1,86	3,94	36,06	10,80	100
PBA439(x/xx)-B30	400x500	30	3,45	2,85	6,30	13,70	5,40	50
PBA439(x/xx)-B60	400x500	60	3,45	2,85	6,30	33,70	10,80	100
PBA439(x/xx)-B150	400x500	150	3,45	2,85	6,30	43,70	27,00	200
PBA439(x/xx)-BC60	500x650	60	7,00	5,80	12,80	27,20	10,80	100
PBA439(x/xx)-BC150	500x650	150	7,00	5,80	12,80	35,00	27,00	250
PBA439(x/xx)-BC300	500x650	300	7,00	5,80	12,80	187,20	54,00	500
PBA439(x/xx)-CC60	600x800	60	9,36	11,00	20,36	19,64	10,80	100
PBA439(x/xx)-CC150	600x800	150	9,36	11,00	20,36	79,64	27,00	250
PBA439(x/xx)-CC300	600x800	300	9,36	11,00	20,36	179,64	54,00	500
PBA439(x/xx)-CC600	600x800	600	11,50	14,10	25,60	124,40	108,00	750

## 6.5.2 Tableau de charge préalable en livres

Type	Dimensions [pouces]	Charge max. (3)	Charge préalable partie sup. (4)	Charge préalable plateau de pesage (5)	Charge préalable sortie usine (6)	Réserve mécanique de charge préalable (7)	Plage de définition de zéro (8)	Plage de charge max. (1)
PBA439(x/xx)-QA6	9x9	10	2,29	2,09	4,39	9,86	1,8	24
PBA439(x/xx)-A6	9,5x11,8	10	3,28	2,71	6,00	8,25	1,8	24
PBA439(x/xx)-A15	9,5x11,8	25	3,28	2,71	6,00	17,51	4,5	49
PBA439(x/xx)-QB15	12x12	25	3,75	3,33	7,08	16,42	4,5	49
PBA439(x/xx)-QB30	12x12	50	3,75	3,33	7,08	53,15	9,0	110
PBA439(x/xx)-QB60	12x12	100	3,75	3,33	7,08	113,39	18,0	220
PBA439(x/xx)-BB30	11,8x15,7	50	4,59	4,10	8,69	51,54	9,0	110
PBA439(x/xx)-BB60	11,8x15,7	100	4,59	4,10	8,69	111,78	18,0	220
PBA439(x/xx)-B30	15,7x19,7	50	7,61	6,28	13,89	46,34	9,0	110
PBA439(x/xx)-B60	15,7x19,7	100	7,61	6,28	13,89	106,57	18,0	220
PBA439(x/xx)-B150	15,7x19,7	250	7,61	6,28	13,89	177,04	45,0	441
PBA439(x/xx)-BC60	19,7x25,6	100	15,43	12,79	28,22	92,24	18,0	220
PBA439(x/xx)-BC150	19,7x25,6	250	15,43	12,79	28,22	157,86	45,0	551
PBA439(x/xx)-BC300	19,7x25,6	500	15,43	12,79	28,22	574,09	90,0	1102
PBA439(x/xx)-CC60	23,6x29,5	100	20,64	24,25	44,89	75,58	18,0	220
PBA439(x/xx)-CC150	23,6x29,5	250	20,64	24,25	44,89	256,27	45,0	551
PBA439(x/xx)-CC300	23,6x29,5	500	20,64	24,25	44,89	557,43	90,0	1102
PBA439(x/xx)-CC600	23,6x29,5	1000	25,35	31,09	56,44	597,03	180,0	1653

## 6.6 Accessoires

### Colonne

Article #	Désignation	Description
72229393	Colonne ouverte 120 mm / 4,7"	Adaptée à toutes les tailles de plate-forme
72198702	Colonne ouverte 330 mm / 13"	Adaptée à toutes les tailles de plate-forme
72198703	Colonne ouverte 660 mm / 26"	Adaptée à toutes les tailles de plate-forme
72198704	Colonne ouverte 900 mm / 35,4"	Adaptée à toutes les tailles de plate-forme plus grandes que la taille A

### Chariot en acier inoxydable

Article #	Désignation	Description
72225939	Chariot en acier inoxydable BC	Adapté à la plateforme de taille BC
72225940	Chariot en acier inoxydable CC	Adapté à la plateforme de taille CC

### Piste de rouleaux

Article #	Désignation	Description
30253326	Piste de rouleaux 400 × 500 mm / 15,7" × 19,7" acier inoxydable	Adaptée à la plateforme de taille B. Roulement vers côté court de plate-forme
30253328	Piste de rouleaux 500 × 650 mm / 19,7" × 25,6" acier inoxydable	Adaptée à la plateforme de taille BC. Roulement vers côté court de plate-forme
30253330	Piste de rouleaux 600 × 800 mm / 23,6" × 31,5" acier inoxydable	Adaptée à la plateforme de taille CC. Roulement vers côté court de plate-forme
30253327	Piste de rouleaux 400 × 500 mm / 15,7" × 19,7" acier inoxydable	Adaptée à la plateforme de taille B. Roulement vers côté long de plate-forme
30253329	Piste de rouleaux 500 × 650 mm / 19,7" × 25,6" acier inoxydable	Adaptée à la plateforme de taille BC. Roulement vers côté long de plate-forme
30253331	Piste de rouleaux 600 × 800 mm / 23,6" × 31,5" acier inoxydable	Adaptée à la plateforme de taille CC. Roulement vers côté long de plate-forme
30640393	Piste de rouleaux 400 × 500 mm / 15,7" × 19,7" acier inoxydable	Adaptée aux zones dangereuses
30640394	Piste de rouleaux 500 × 650 mm / 19,7" × 25,6" acier inoxydable	Adaptée aux zones dangereuses
30640395	Piste de rouleaux 600 × 800 mm / 23,6" × 31,5" acier inoxydable	Adaptée aux zones dangereuses

### Support de montage avant

Article #	Désignation	Description
22021062	Support de montage avant	Adapté au montage avant ICS4_9

### Plateau en acier inoxydable

Article #	Désignation	Description
30676769	Plateau en acier inoxydable AISI 316 240 x 300 mm / 9,5" x 11,8"	Adapté à la plate-forme de taille A
30676770	Plateau en acier inoxydable AISI 316 300 x 400 mm / 11,8" x 15,7"	Adapté à la plate-forme de taille BB
30676771	Plateau en acier inoxydable AISI 316 400 x 500 mm / 15,7" x 19,7"	Adapté à la plate-forme de taille B.
30676772	Plateau en acier inoxydable AISI 316 228 x 228 mm / 9" x 9"	Adapté à la plate-forme de taille QA
30676773	Plateau en acier inoxydable AISI 316 305 x 305 mm / 12" x 12"	Adapté à la plate-forme de taille QB
30676774	Plateau en acier inoxydable AISI 316 500 x 650 mm / 19,7" x 25,6"	Adapté à la plate-forme de taille BC

Article #	Désignation	Description
30676775	Plateau en acier inoxydable AISI 316 épaisseur 2 mm, 600 x 800 mm / 23,6" x 31,5"	Adapté à la plateforme de taille CC
30676776	Plateau en acier inoxydable AISI 316 épaisseur 2,5 mm, 600 x 800 mm / 23,6" x 31,5"	Adapté à la plateforme de taille CC

## 7 Possibilités de montage

Le PBA439(x/xx) supporte le montage sur dispositif stable. Si le perçage sur la plate-forme de pesage est nécessaire, suivez le schéma de perçage ci-après.



**NOTE : les zones ombragées sont les points où le perçage sur la plate-forme de pesage est autorisé.**

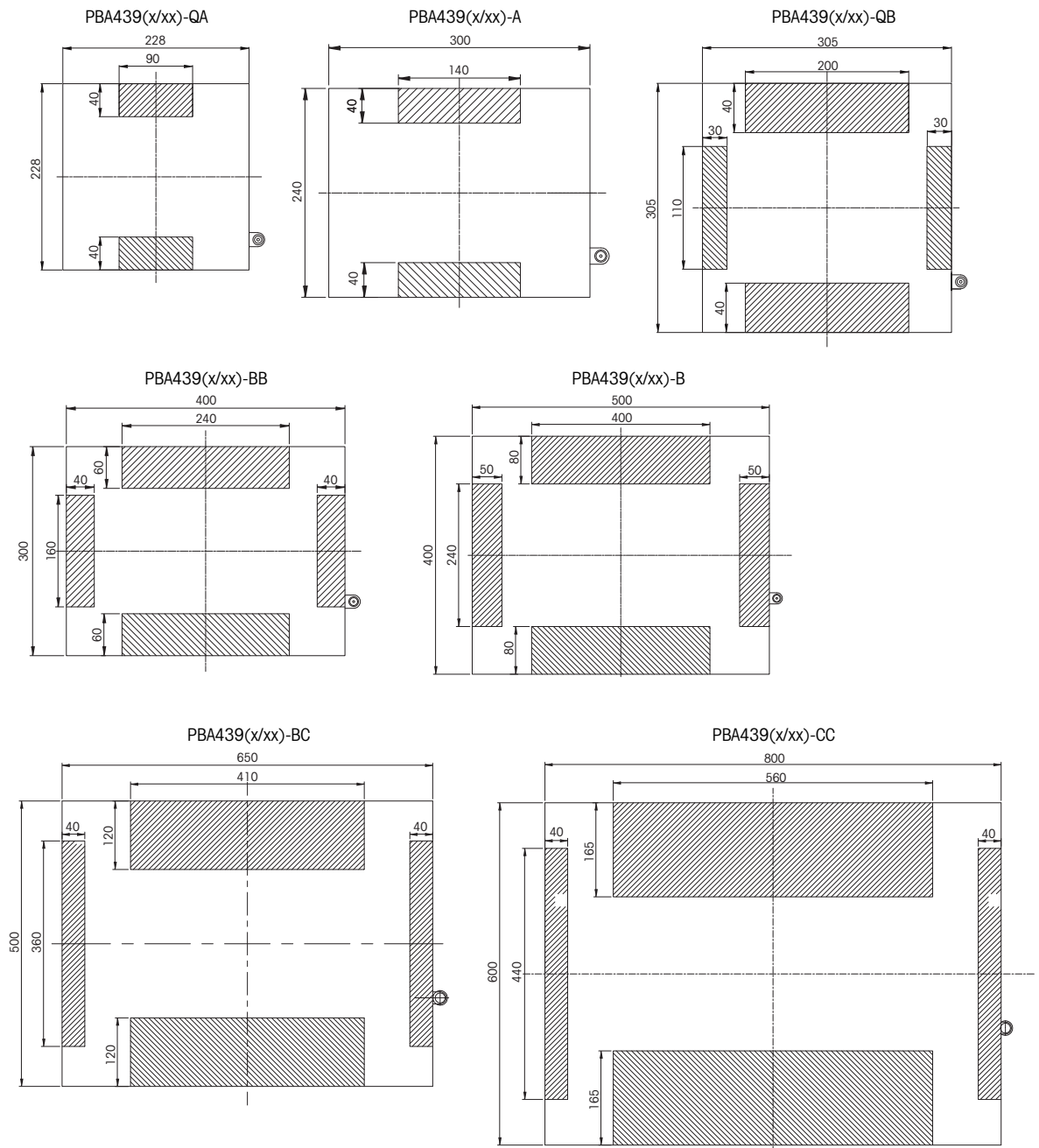

Dimensions en [mm]



## 8 Annexe

### 8.1 Étiquette

<p>IS CL I,II,III DIV 1, GP ABCDEFG T6...T4          Class I, Zone 1, AEx ia IIC T6...T4 Gb          Class II,III, Zone21, AEx ia IIIC T80°C Db          -40°C ≤ Ta ≤ 60°C T5/T4; -40°C ≤ Ta ≤ 40°C T6          FM21US0076X</p>			<p>II 2G Ex ia IIC T6...T4 Gb          II 2D Ex ia IIIC T80°C Db          -40°C ≤ Ta ≤ 60°C T5/T4          -40°C ≤ Ta ≤ 40°C T6</p>
<p>IS CL I,II,III DIV 1, GP ABCDEFG T6...T4          Class I, Zone 1, Ex ia IIC T6...T4 Gb          Class II,III, Zone21, Ex ia IIIC T80°C Db          -40°C ≤ Ta ≤ 60°C T5/T4; -40°C ≤ Ta ≤ 40°C T6          FM21CA0051X</p>		<p>Entity/NIFW for Nonincendive Field Wiring. Entity parameters are shown in drawing 30688074          Mettler-Toledo GmbH, Im Langacher 44, 8606 Greifensee, Switzerland</p>	

<p>NI CL I,II,III DIV 2 GP ABCDFG T6          -40°C ≤ Ta ≤ 60°C          FM21US0076X</p>			<p>II 3G Ex ic IIC T6...T4 Gc          -40°C ≤ Ta ≤ 60°C T5/T4          -40°C ≤ Ta ≤ 40°C T6</p>
<p>NI CL I,II,III DIV 2 GP ABCDEFG T6...T4          -40°C ≤ Ta ≤ 60°C          Class I, Zone 2, Ex ec IIC T6 Gc;          Class II,III, Zone22, Ex tc IIIC T80°C Dc          FM21CA0051X</p>		<p>II 3G Ex ec IIC T6 Gc U-rated=20V          II 3D Ex tc IIIC T80°C Dc I-rated=50mA          -40°C ≤ Ta ≤ 60°C</p>	
		<p>Entity/NIFW for Nonincendive Field Wiring. Entity parameters are shown in drawing 30688074          Mettler-Toledo GmbH, Im Langacher 44, 8606 Greifensee, Switzerland</p>	

## 8.2 Plan de contrôle

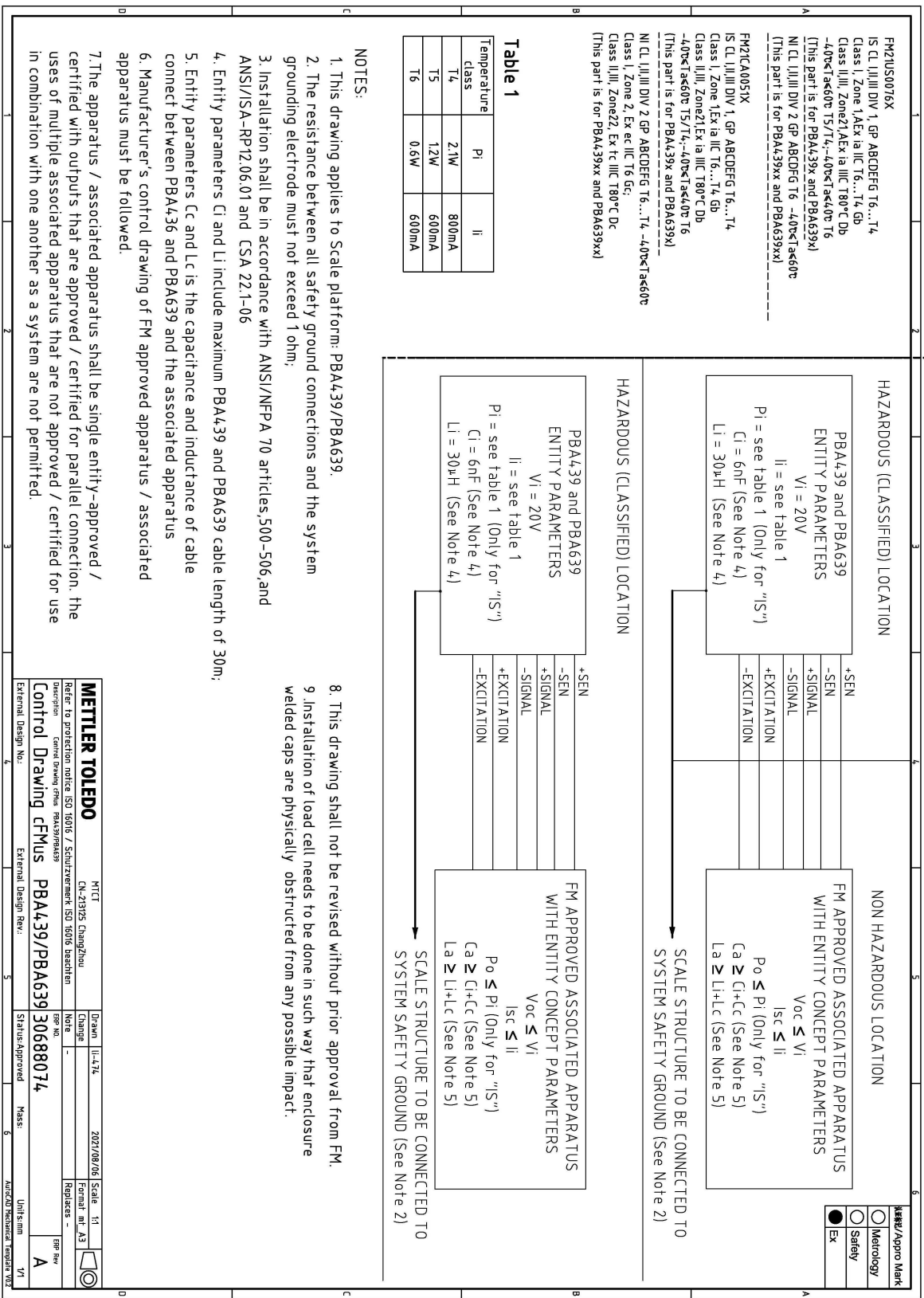

<b>METTLER TOLEDO</b>		MTC	Scale: 1t
Refer to protection notice ISO 10316 / Schutzvermerk ISO 10316 beachten		DN-23125 Changzhou	Formel: ml A3
Description: Control Drawing CFHus		External Design No.: PBA439/PBA639 30688074	Replaces: -
External Design Rev.: 6		Status: Approved	REP Rev: A

### 8.3 Dessin d'installation

#### Hazardous (Classified) Location

IP67 II 3G Ex ic IIC T6...T4 Gc  
-40°C ≤ Tas ≤ 60°C T5/T4; -40°C ≤ Tas ≤ 40°C T6

II 3G Ex ec IIC T6 Gc -40°C ≤ Tas ≤ 60°C T6  
II 3D Ex tc IIIC T80°C Dc  
FM21UKEX0080X  
FM21ATEX0025X IECEX FMG21.0003X

---

II 2G Ex ia IIC T6...T4 Gb  
-40°C ≤ Tas ≤ 60°C T5/T4; -40°C ≤ Tas ≤ 40°C T6

II 2D Ex ia IIIC T80°C Db  
FM21UKEX0079X  
FM21ATEX0003X IECEX FMG21.0003X

Approval Mark

THIS ITEM IS PART OF AGENCY APPROVED PRODUCT

Metrology  
 Safety  
 Ex

DO NOT CHANGE DOCUMENT WITHOUT APPROPRIATE APPROVAL

SLP84x Load Cell

U<sub>i</sub> = 20V  
l<sub>i</sub> = see table2  
P<sub>i</sub> = see table 2  
C<sub>i</sub> = 6nF  
L<sub>i</sub> = 30uH

+Excitation(Green)

-Excitation(Black)

+SEN(Yellow)

-SEN(Blue)

+Signal(White)

-Signal(Red)

Ex Approved Associated Apparatus with Entity Concept Parameters

U<sub>o</sub> ≤ U<sub>i</sub>  
I<sub>o</sub> ≤ I<sub>i</sub>  
P<sub>o</sub> ≤ P<sub>i</sub>  
C<sub>o</sub> ≥ C<sub>c</sub> + C<sub>i</sub>  
L<sub>o</sub> ≥ L<sub>c</sub> + L<sub>i</sub>

Scale structure (attached to load cell) to be connected to system safety ground. See Note.

**NOTES:**

- 1.The resistance between all safety ground connections and the system grounding electrode must not exceed 1ohm.
- 2.Installation shall be in accordance with relevant electrical installation standards (Being shown in Table 1)in hazardous areas(other than mines).
- 3.Entity Parameters C<sub>i</sub> And L<sub>i</sub> Include Maximum Load Cell Cable Length Of 30m
- 4.Entity Parameters C<sub>c</sub> and L<sub>c</sub> is the capacitance and inductance of cable connect between load cell and the associated apparatus.
- 5.In an explosive atmosphere caused by air/dust mistures, the loose ends of the cable shall be connected outside the hazardous area or in a suitable enclosure with a degree of protection of at least IP6X in accordance with EN 60529.
- 6.For the application of Ex ec, Ex tc: U<sub>rated</sub>=20V,I<sub>rated</sub>=50mA.
- 7.Installation of load cell needs to be done in such way that enclosure welded caps are physically obstructed from any possible impact.
8. ⚠ Not following these instructions will jeopardize the explosion safety.
9. For the application of Ex ec, The equipment shall only be used in an area of at least pollution degree 2, as defined in IEC 60664-1.

Table 1

EN60079-0: 2018	EN60079-14: 2014	EN60079-11: 2012	EN60079-31: 2014
EN61241-14: 2004	EN60079-31: 2013	EN60079-7: 2015	IEC60079-31: 2013
IEC 60079-0-2017	IEC 60079-11-2011	IEC 60079-14-2013	IEC60079-7: 2015

Table 2

Temperature class	P <sub>i</sub>	l <sub>i</sub>
T4	2.1W	800mA
T5	1.2W	600mA
T6	0.6W	600mA

Mettler-Toledo GmbH, Im Langacher 44, 8606 Greifensee, Switzerland  
Mettler-Toledo Ltd. 64 Boston Rd.Leicester, LE4 1AW, United Kingdom

D	update drawing status	Wang Jianwen	Liu Yuchun		2021-7-26
C	removed Ex nA of note6	Wang Jianwen	Liu Yuchun		2021-1-15
REV / CHG	DESCRIPTION	BY	APPVD	AGENCY	E.R. No. DATE
RECORD OF CHANGES					
<b>METTLER TOLEDO</b>		MTCZ	Drawn	Wang JW	2020/05/11
		CN-213022 ChangZhou	Change		Scale 1:1
Refer to protection notice ISO 16016 / Schutzvermerk ISO 16016 beachten			Note	-	Format mt_A4
Description 防爆安装图 SLP84X		ERP NO.			Replaces -
<b>INSTALLATION DRAWING SLP84X ATEX/IECEX</b>		<b>30555321</b>			<b>D</b>
External Design No.:D000644580		External Design Rev.:D		Status:Approved	Mass: Units:mm 1/1

AutoCAD Mechanical Template V0.2



# METTLER TOLEDO Service

Felicidades por escoger la calidad y precisión de METTLER TOLEDO. El uso apropiado conforme a este manual de usuario, así como el calibrado y el mantenimiento regulares proporcionado por nuestro equipo de servicio entrenado en nuestra fábrica le asegura el funcionamiento fiable y correcto, protegiendo así su inversión. Consúltenos con respecto a un contrato de servicio adaptado a sus necesidades y presupuesto. Hay más información disponible en ► [www.mt.com/service](http://www.mt.com/service).

Hay varias maneras importantes para garantizar el máximo rendimiento de su inversión:

- 1 **Registre su producto:** Le invitamos a registrar su producto en [www.mt.com/productregistration](http://www.mt.com/productregistration) de manera que le podamos informar sobre mejoras, actualizaciones y notificaciones importantes referentes a su producto.
- 2 **Contacte con METTLER TOLEDO para el servicio:** El valor de una medida es proporcional a su precisión. Una balanza fuera de especificación puede disminuir la calidad, reducir los beneficios y aumentar la responsabilidad. El servicio oportuno de METTLER TOLEDO garantizará la precisión y optimizará el tiempo de actividad y la vida útil del equipo.
  - ➔ **Instalación, configuración, integración y entrenamiento:** Nuestros representantes de servicio son expertos en equipos de pesaje entrenados en la fábrica. Nos aseguramos de que su equipo de pesaje está listo para la producción de una manera eficaz y oportuna de costos y que el personal está capacitado para el éxito.
  - ➔ **Documentación de calibración inicial:** El entorno de instalación y los requisitos de aplicación son únicos para cada balanza industrial de modo que el rendimiento debe ser probado y certificado. Nuestros servicios de calibración y certificados documentan la exactitud para garantizar la calidad de la producción y proporcionan un registro del sistema de calidad del rendimiento.
  - ➔ **Mantenimiento de calibración periódica:** Un acuerdo de servicio de calibración proporciona en curso confianza en su proceso de pesaje y documentación de cumplimiento de los requisitos. Ofrecemos una variedad de planes de servicio que están programados para satisfacer sus necesidades y diseñados para ajustarse a su presupuesto.



# Índice de contenidos

<b>1</b>	<b>Instrucciones de seguridad</b>	<b>3</b>
1.1	Uso previsto .....	3
1.2	Mal uso .....	3
1.3	Precauciones de seguridad .....	3
1.4	Condiciones específicas de utilización.....	3
<b>2</b>	<b>Introducción</b>	<b>4</b>
2.1	Variedad .....	4
2.2	Acerca de este manual .....	4
2.3	Otros documentos.....	4
<b>3</b>	<b>Instalación y manejo</b>	<b>5</b>
3.1	Conexión de la plataforma de pesada al terminal de pesada .....	5
3.2	Nivelación.....	6
3.3	Compensación de potencial.....	6
3.4	Comprobación de la plataforma de pesada.....	6
3.5	Manejo de la plataforma de pesada .....	7
3.6	Instalación, configuración, servicio y reparación .....	7
<b>4</b>	<b>Mantenimiento</b>	<b>8</b>
4.1	Notas sobre la limpieza.....	8
4.2	Tratamiento posterior.....	8
4.3	Eliminación .....	9
<b>5</b>	<b>Reparación</b>	<b>10</b>
<b>6</b>	<b>Datos técnicos y límites de operación</b>	<b>11</b>
6.1	Intervalo máximo de balanza contrastada .....	11
6.2	Carga máxima permitida .....	11
6.3	Datos técnicos de la célula de carga.....	12
6.3.1	Aprobación Ex .....	12
6.3.2	Estándar de conformidad de la célula de carga .....	12
6.4	Dimensiones .....	14
6.5	Información sobre capacidad, carga previa .....	15
6.5.1	Tabla de cargas previas en kilos.....	16
6.5.2	Tabla de cargas previas en libras .....	17
6.6	Accesorios .....	18
<b>7</b>	<b>Opciones de montaje</b>	<b>20</b>
<b>8</b>	<b>Apéndice</b>	<b>21</b>
8.1	Etiqueta .....	21
8.2	Plano de control .....	22
8.3	Plano de instalación .....	23



# 1 Instrucciones de seguridad

## 1.1 Uso previsto

Las plataformas de pesada PBA439(x/xx) forman parte de un sistema de pesada modular que consiste en un terminal de pesada METTLER TOLEDO como indicador y, al menos, una plataforma de pesada.

- Utilizar la plataforma de pesada sólo para pesar de acuerdo con este manual.
- La plataforma de pesada está diseñada sólo para uso en interiores.
- Solo la plataforma de pesada de los PBA439x/xx es adecuada para su uso en entornos peligrosos, tal como se especifica a continuación.
- Cualquier otro tipo de uso se considera como no previsto.

### Metrología legal

- Para el uso en metrología legal sólo utilizar plataformas de pesada aprobadas.
- Al utilizar la metrología en forma legal, la empresa operadora es responsable de observar todos los pesos nacionales y los requisitos de las mediciones.
- Por favor, póngase en contacto con la organización de servicio METTLER TOLEDO para preguntas relacionadas con el uso legal para aplicaciones comerciales.

## 1.2 Mal uso

- No utilizar el terminal de pesada para otros fines que no sean operaciones de pesada.
- No utilizar la plataforma de pesada en un entorno distinto al especificado en la sección de --- MISSING LINK ---.
- No modificar la plataforma de pesada.
- No utilizar el terminal de pesada más allá de los límites de las especificaciones técnicas.
- No utilizar la plataforma de pesada para el almacenamiento de mercancías.
- Evitar la caída de mercancías en la plataforma de pesada.

## 1.3 Precauciones de seguridad

- Sólo personal entrenado y calificado por METTLER TOLEDO puede instalar y dar mantenimiento a la plataforma de pesada.
- Tener cuidado al transportar o levantar aparatos pesados.
- Siempre desconectar la plataforma de pesada de la fuente de alimentación antes de instalar, revisar, limpiar o efectuar el mantenimiento.
- El cable de conexión no puede ser desconectado del terminal de pesada mientras está bajo tensión.
- Asegurar que la plataforma de pesada haya alcanzado la temperatura ambiente antes de encender la alimentación de corriente.
- Las plataformas de pesada protegidas contra explosión de los PBA439x/xx están aprobadas para el uso en las siguientes zonas peligrosas:
  - ATEX/IECEx categoría 2, categoría 3, gas/polvo (zona 1/21, zona 2/22)
  - cFMus, clase I, II, III, div. 1, div. 2
- ¡Hay mayor riesgo de lesiones y daños si las plataformas de pesada se utilizan en zonas peligrosas! Especial cuidado se debe tener cuando se trabaja en susodichas zonas.
- En el caso de la plataforma de pesada de los PBA439x/xx, solo deberán utilizarse prensaestopas adecuados y aprobados para zonas peligrosas, para insertar el cable de la célula de pesada en el terminal de pesada.
- Las plataformas de pesada protegidas contra explosiones sólo podrán ser utilizadas en zonas peligrosas junto con terminales de pesada con la especificación apropiada de la aprobación y el interface.

## 1.4 Condiciones específicas de utilización

- En una atmósfera explosiva originada por la humedad del polvo/aire, los extremos sueltos del cable deberán conectarse fuera de la zona peligrosas o dentro de una carcasa adecuada, con un grado de protección de al menos IP6X conforme a IEC/EN 60529.

## 2 Introducción

### 2.1 Variedad

Este manual se centra en la serie de productos del PBA439(x/xx).

Las series del PBA439(x/xx) ofrecen una variedad de plataformas de pesada para adaptarse a sus necesidades. Es de aprobación y ofrece varios tamaños y capacidades

Tipo	Material plato de carga	Material bastidor de balanza	Diseño célula de carga	Entorno, protección IP	Peligroso aprobación
PBA439	Acero inoxidable AISI304	Acero inoxidable AISI304	Acero inoxidable, sellado herméticamente	Seco, húmedo, IP68/IP69K	-
PBA439x					Zona 1/21, div 1
PBA439xx					Zona 2/22, div 2

### 2.2 Acerca de este manual



Este manual contiene toda la información para el operador del producto.

- Leer este manual detenidamente antes del uso.
- Guardar este manual para poder consultarlo en un futuro.
- Entregar este manual a cualquier futuro propietario o usuario del producto.

### 2.3 Otros documentos

En complemento a este manual impreso puede descargar los siguientes documentos desde ► [www.mt.com](http://www.mt.com):

- Folletos
- Información de instalación (para personal entrenado bajo el control de la empresa operadora)
- Documentos de aprobación del tipo

#### Descarga de certificados

Los certificados US, Canadá, ATEX, UKEX e IECEx pueden descargarse desde

► <https://www.mt.com/us/en/home/search/compliance.html/compliance/>.

## 3 Instalación y manejo

### 3.1 Conexión de la plataforma de pesada al terminal de pesada

Las plataformas de pesada del PBA439(x/xx) están diseñadas para el uso con terminales analógicos METTLER TOLEDO.

- 1 Pasar el cable de plataforma de pesada al terminal de pesada a través del prensaestopas.
- 2 Conectar el cable de la plataforma de pesada a la regleta de terminales del terminal de pesada, conforme a la siguiente tabla.

Señal	Color del cable	Conector
SIG+	Blanco	
SIG-	Rojo	
EXC+	Verde	
EXC-	Negro	
SEN+	Amarillo	
SEN-	Azul	



#### ADVERTENCIA

**El blindaje del cable tiene que estar conectado a tierra.**

#### Precauciones de seguridad para las conexiones

- Al conectar la plataforma de pesada en zonas peligrosas, es obligatorio respetar estrictamente los requisitos indicados en los planos de control disponibles en el [Apéndice ▶ página 21].
- Comprobar las condiciones especiales del uso seguro en los planos y los certificados del [Apéndice ▶ página 21].
- El blindaje del cable está conectado al elemento de resorte de la célula de carga (el cuerpo de la célula de carga). Asegurar la conexión adecuada entre la célula de carga y el terminal (o caja de bornes), de acuerdo con el escenario de instalación.
- La resistencia entre todas las conexiones de tierra de seguridad y el electrodo de tierra del sistema no deberá exceder 1 ohm.
- La instalación tiene que cumplir los estándares relevantes de instalaciones eléctricas.
- La inobservancia de estas instrucciones pondrá en riesgo la seguridad contra explosiones.

### 3.2 Nivelación

Sólo una plataforma de pesada instalada exactamente en posición horizontal suministrará resultados de pesada exactos. La plataforma de pesada debe nivelarse en la primera instalación y después de cada cambio de sitio.

- 1 Girar los pies de nivelación de la plataforma de pesada, hasta que la burbuja del nivel quede en el círculo interior.
- 2 Apretar bien las contratueras de los pies de nivelación.

👉 **Escanee el código QR para ver el vídeo**

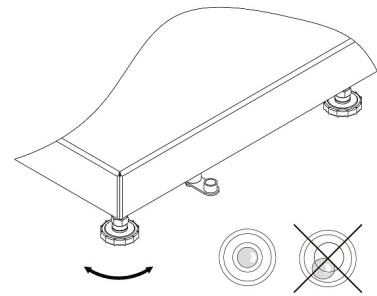

### 3.3 Compensación de potencial

La compensación de potencial para las plataformas de pesada de los PBA439x/xx se monta en la fábrica. El cableado debe ser instalado por un electricista profesional en el sitio del cliente. El servicio METTLER TOLEDO tiene aquí sólo una función de control y consulta. Conectar la compensación de potencial (PA) de todos los dispositivos (plataforma de pesada y terminal de pesada) de conformidad con los reglamentos y normas específicas de cada país. En el proceso, asegurar que todas las carcasas de los aparatos estén conectadas al mismo potencial a través del terminal PA.

#### Nota

El equipo está protegido contra descargas eléctricas según IEC 60950, clase II.

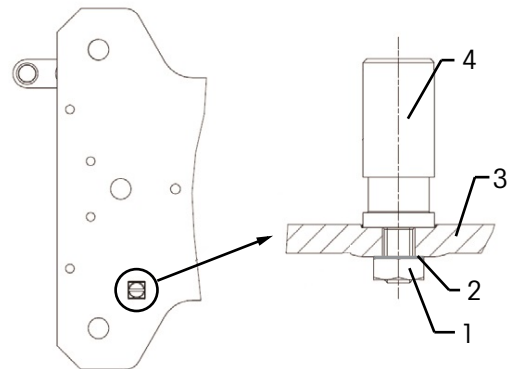

- 1 - Contratueras hexagonal, M4 KEPS
- 2 - Arandela
- 3 - Bastidor base
- 4 - Compensación de potencial terminal, par 3,5 Nm

N.º de pedido del kit de compensación de potencial 72237321

### 3.4 Comprobación de la plataforma de pesada

#### Control de funciones

- 1 Asegurarse de que la plataforma de pesada está conectada a un terminal de pesada, y que el terminal de pesada esté conmutado a On.
- 2 Asegurarse de que la plataforma de pesada está descargada y el display del terminal de pesada muestra 0.
- 3 Cargar la plataforma de pesada. El terminal de pesada debe mostrar un valor diferente a 0.
- 4 Descargar la plataforma de pesada. El terminal de pesada debe retornar a 0.

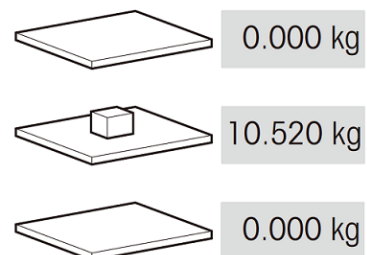

#### Prueba de contrastado

Para una prueba de contrastado consultar el manual de usuario del terminal de pesada conectado. Si el precinto de contrastado se rompe, ya no es válido el contrastado.



### 3.5 Manejo de la plataforma de pesada

Para mejores resultados de las pesadas, observar lo siguiente:

- Asegúrese de que la placa de carga está colocada correctamente.

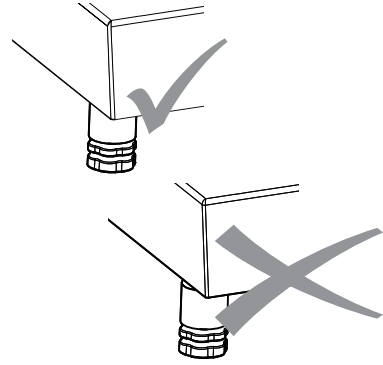

- Para lograr mejores resultados de pesada colocar la mercancía para pesar siempre en la misma posición en la plataforma de pesada.

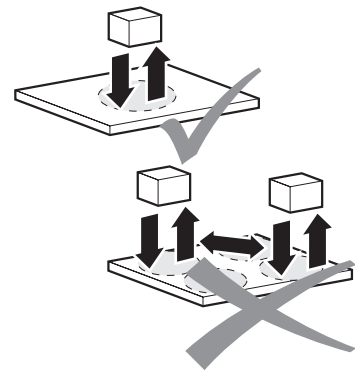

- Evitar abrasivos y procesos de desgaste.

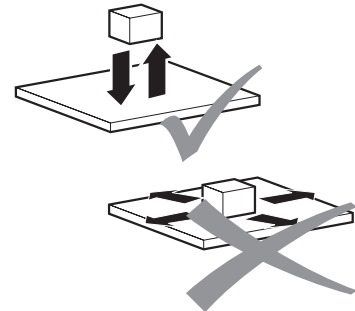

- Evite los golpes, los impactos laterales y que la carga se caiga

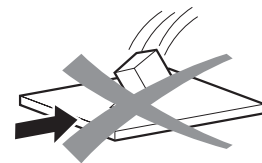

### 3.6 Instalación, configuración, servicio y reparación

Para la instalación, configuración, mantenimiento y reparación de las plataformas de pesada llamar al servicio METTLER TOLEDO.

## 4 Mantenimiento

### 4.1 Notas sobre la limpieza

#### Nota

##### **Daño a la plataforma de pesada debido al uso incorrecto de los agentes limpiadores.**

- Utilizar únicamente desinfectantes y agentes limpiadores de acuerdo con las instrucciones del fabricante.
- No utilizar agentes limpiadores altamente ácidos, altamente alcalinos o altamente clorados. Evitar sustancias con un pH alto o bajo, ya que de otra manera existe mayor peligro de corrosión.
- Tener especial cuidado al limpiar la célula de carga.

#### Procedimiento de limpieza

- Eliminar la suciedad y los sedimentos a intervalos regulares desde fuera y el interior de la plataforma de pesada.
  - ➔ El procedimiento depende tanto del tipo de superficie y de las condiciones medioambientales que prevalecen en el lugar de instalación.

#### Limpeza en un entorno húmedo (versiones de acero inoxidable)

- Utilizar un chorro de agua de hasta 80 °C / 176 °F y máx. 80 bares, a una distancia mínima de 40 cm / 16".
- Utilizar agentes limpiadores para uso doméstico.

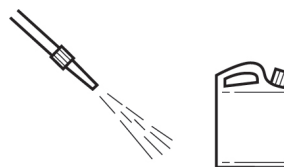

#### Limpeza en un entorno corrosivo (versiones de acero inoxidable)

- Usar un chorro de agua.  
**Limpeza interior**, célula de carga, plato de carga abierto: hasta 60 °C / 140 °F y máx. 2 bares, distancia mínima 40 cm / 16".

**Limpeza exterior**, plato de carga cerrado: hasta 80 °C / 176 °F y máx. 80 bares, distancia mínima 40 cm / 16".

- Eliminar sustancias corrosivas a intervalos regulares.
- Utilizar únicamente desinfectantes y agentes limpiadores de acuerdo con las instrucciones del fabricante

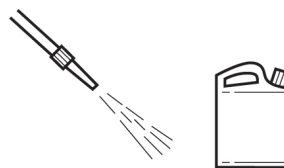

### 4.2 Tratamiento posterior

Con el fin de proteger la balanza, llevar a cabo el siguiente tratamiento posterior:

- Enjuagar la balanza con agua limpia y retirar el agente limpiador por completo.
- Secar la balanza con un paño que no se deshilache.
- Con las balanzas de acero inoxidable, tratar el interior y el exterior con un aceite adecuado para materias alimenticias.

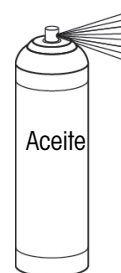

### 4.3 Eliminación

Conforme a las exigencias de la Directiva 2012/19/UE sobre residuos de aparatos eléctricos y electrónicos (RAEE), esta unidad no debe eliminarse con la basura doméstica. Esta prohibición es asimismo válida para los países que no pertenecen a la UE cuyas normativas nacionales en vigor así lo reflejan.

Elimine este producto, según las disposiciones locales, mediante el sistema de recogida selectiva de aparatos eléctricos y electrónicos. Si tiene alguna pregunta al respecto, diríjase a las autoridades responsables o al distribuidor que le proporcionó el equipo. En caso de que este dispositivo se transfiera a terceros, deberá transmitirse también el contenido de esta normativa.



## **5 Reparación**

Este equipo está certificado para su uso en ubicaciones peligrosas, por lo que no se permite realizar ningún tipo de modificación. Las reparaciones deberán realizarse exclusivamente por personal especialmente formado para la reparación de estos equipos.

## 6 Datos técnicos y límites de operación

### 6.1 Intervalo máximo de balanza contrastada

Interv. máx. de balanza contrast. [e] / OIML	Capacidad							
	3 kg	6 kg	15 kg	30 kg	60 kg	150 kg	300 kg	600 kg
1 x 3000e Max / e [kg]	3 / 0.001	6 / 0.002	15 / 0.005	30 / 0.01	60 / 0.02	150 / 0.05	300 / 0.1	600 / 0.2

Interv. máx. de balanza contrast. [d] / NTEP	Capacidad							
	-	10 lb	25 lb	50 lb	100 lb	250 lb	500 lb	1000 lb
1 x 5000d Max / d [lb]	-	10 / 0.002	25 / 0.005	50 / 0.01	100 / 0.02	250 / 0.05	500 / 0.1	1000 / 0.2

### 6.2 Carga máxima permitida

Todas las plataformas de pesada están equipadas con una protección de sobrecarga. La plataforma de pesada es de solidez extrema, de modo que si se sobrepasa ocasionalmente la carga máxima de pesada no se origina ningún daño. La carga límite estática máxima no se debe sobrepasar.

- Observar los siguientes límites de operación.

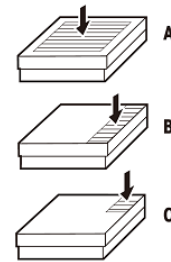

Modelo	A - Carga central	B - Carga lateral	C - Carga unilateral en esquina
PBA439(x/xx)-QA	40 kg / 80 lb	30 kg / 60 lb	15 kg / 30 lb
PBA439(x/xx)-A	40 kg / 80 lb	30 kg / 60 lb	15 kg / 30 lb
PBA439(x/xx)-QB	100 kg / 200 lb	70 kg / 140 lb	35 kg / 70 lb
PBA439(x/xx)-BB	100 kg / 200 lb	70 kg / 140 lb	35 kg / 70 lb
PBA439(x/xx)-B	200 kg / 400 lb	140 kg / 280 lb	75 kg / 150 lb
PBA439(x/xx)-BC	400 kg / 800 lb	300 kg / 600 lb	150 kg / 300 lb
PBA439(x/xx)-CC	700 kg / 1400 lb	400 kg / 800 lb	200 kg / 400 lb



#### **ADVERTENCIA**

**Evitar la caída de las cargas, su colocación violenta y los golpes laterales.**

### 6.3 Datos técnicos de la célula de carga

Salida medida	mV/V	1,8 ± 0,2
Resistencia de entrada	Ω	384 ± 15
Resistencia de salida	Ω	350 ± 4
Voltaje recomendado	V (CC/CA)	5 - 15
Voltaje máx. de excitación	V (CC/CA)	20
Funda del cable	-	PVC
Clasificación IP	-	IP68/IP69K

#### 6.3.1 Aprobación Ex

Esta sección cubre solo los aspectos relevantes a Ex del producto.

La célula de carga SLP84x(x=6,7,8) se ha concedido con:

Certificado ATEX	FM21ATEX0003X, FM21ATEX0025X
Certificado UK	FM21UKEX0079X, FM21UKEX0080X
Certificado IECEx	IECEx FMG21.0003X
Certificado US	FM21US0005X
Certificado de Canadá	FM21CA0002X

Para consultar los certificados anteriormente mencionados y los planos, remitirse al [Apéndice ► página 21].

#### 6.3.2 Estándar de conformidad de la célula de carga

##### Estándares US

Título	Número	Fecha de emisión
Equipos eléctricos para uso en ubicaciones (clasificadas) peligrosas: requisitos generales	FM clase 3600	2018
Equipos de seguridad intrínseca y equipos asociados para uso en ubicaciones (clasificadas) peligrosas de clase I, II y III, división 1	FM clase 3610	2021
Equipos eléctricos ignífugos para uso en ubicaciones (clasificadas) peligrosas de clase I y II, división 2, y clase III, divisiones 1 y 2	FM clase 3611	2021
Equipos eléctricos de medición, control y uso en laboratorio	FM clase 3810	2021
Atmósferas explosivas. Parte 0: Equipos. Requisitos generales	ANSI/UL 60079-0	2019
Atmósferas explosivas. Parte 11: Protección de equipos mediante seguridad intrínseca «i»	ANSI/ISA 60079-11	2014
Equipos eléctricos ignífugos para uso en ubicaciones (clasificadas) peligrosas de clase I y II, división 2, y clase III, divisiones 1 y 2	ANSI/UL 121201	2017
Requisitos de seguridad para eléctricos de medición, control y uso en laboratorio. Parte 1: Requisitos generales	ANSI/UL 61010-1	2012
Grados de protección proporcionados por carcasas (código IP)	ANSI/IEC 60529	2020

##### Estándares de Canadá

Título	Número	Fecha de emisión
Equipos eléctricos ignífugos para uso en ubicaciones peligrosas de clase I, división 2	CSA C22.2 N.º 213	2017
Atmósferas explosivas. Parte 0: Equipos. Requisitos generales	CAN/CSA-C22.2 N.º 60079-0	2019
Atmósferas explosivas. Parte 11: Protección de equipos mediante seguridad intrínseca «i»	CAN/CSA-C22.2 N.º 60079-11	2014
Atmósferas explosivas. Parte 7: Protección de equipos mediante seguridad incrementada «e»	CAN/CSA-C22.2 N.º 60079-7	2018

Título	Número	Fecha de emisión
Atmósferas explosivas. Parte 31: Protección de ignición por polvo de equipos mediante carcasa «t»	CAN/CSA-C22.2 N.º 60079-31	2015
Requisitos de seguridad para eléctricos de medición, control y uso en laboratorio. Parte 1: Requisitos generales	CSA C22.2 N.º 61010-1	2012
Grados de protección proporcionados por carcacas (código IP)	CSA C22.2 N.º 60529	2016

### Estándares IECEx

Título	Número	Fecha de emisión
Atmósferas explosivas. Parte 0: Equipos. Requisitos generales	IEC 60079-0	2017
Atmósferas explosivas. Parte 11: Protección de equipos mediante seguridad intrínseca «i»	IEC 60079-11	2011
Atmósferas explosivas. Parte 7: Protección de equipos mediante seguridad incrementada «e»	IEC 60079-7	2017
Atmósferas explosivas. Parte 31: Protección de ignición por polvo de equipos mediante carcasa «t»	IEC 60079-31	2013
Grados de protección proporcionados por carcacas (código IP)	IEC 60529	2013

### Estándares ATEX

Título	Número	Fecha de emisión
Atmósferas explosivas. Parte 0: Equipos. Requisitos generales	EN IEC 60079-0	2018
Atmósferas explosivas. Parte 11: Protección de equipos mediante seguridad intrínseca «i»	EN 60079-11	2012
Atmósferas explosivas. Parte 7: Protección de equipos mediante seguridad incrementada «e»	EN 60079-7	2015 +A1:2018
Atmósferas explosivas. Parte 31: Protección de ignición por polvo de equipos mediante carcasa «t»	EN 60079-31	2014
Grados de protección proporcionados por carcacas (código IP)	EN 60529	1991 + A1:2000 + A2:2013

### Estándares UKEX

Título	Número	Fecha de emisión
Atmósferas explosivas. Parte 0: Equipos. Requisitos generales	EN IEC 60079-0	2018
Atmósferas explosivas. Parte 11: Protección de equipos mediante seguridad intrínseca «i»	EN 60079-11	2012
Atmósferas explosivas. Parte 7: Protección de equipos mediante seguridad incrementada «e»	EN 60079-7	2015 +A1:2018
Atmósferas explosivas. Parte 31: Protección de ignición por polvo de equipos mediante carcasa «t»	EN 60079-31	2014
Grados de protección proporcionados por carcacas (código IP)	EN 60529	1991 + A1:2000 + A2:2013

## 6.4 Dimensiones

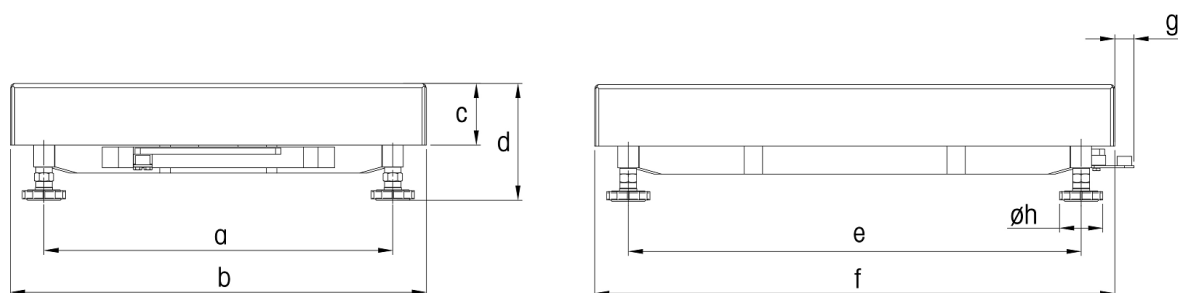

Dimensiones		a	b	c	d *	e	f	g	h
PBA439(x/xx)-QA	mm	163	228	56	85,6	163	228	21	42
	pulgadas	6,42	8,98	2,20	3,37	6,42	8,98	0,83	1,65
PBA439(x/xx)-A	mm	175	240	56	85,6	235	300	21	42
	pulgadas	6,89	9,45	2,20	3,37	9,25	11,81	0,83	1,65
PBA439(x/xx)-QB	mm	240	305	57	96,6	253	305	18	42
	pulgadas	9,45	12,01	2,24	3,8	9,96	12,01	0,71	1,65
PBA439(x/xx)-BB	mm	235	300	57	96,6	335	400	18	42
	pulgadas	9,25	11,81	2,24	3,8	13,19	15,75	0,71	1,65
PBA439(x/xx)-B	mm	335	400	59	100,1	435	500	18	42
	pulgadas	13,19	15,75	2,32	3,94	17,13	19,69	0,71	1,65
PBA439(x/xx)-BC	mm	437	500	73	106,8	584	650	17	42
	pulgadas	17,20	19,69	2,87	4,2	22,99	25,59	0,67	1,65
PBA439(x/xx)-CC	mm	503	600	85	128,3	724	800	18	42
	pulgadas	19,80	23,62	3,35	5,05	28,5	31,50	0,71	1,65

\*: 1) d= altura mínima de la plataforma. Con la pata ajustable de la balanza, la altura de la plataforma puede incrementarse en 10 mm / 0,39 pulgadas como máximo.

2) Con la opción del kit de higiene, la altura mínima de la plataforma (d) aumenta en 12 mm / 0,47".



## 6.5 Información sobre capacidad, carga previa

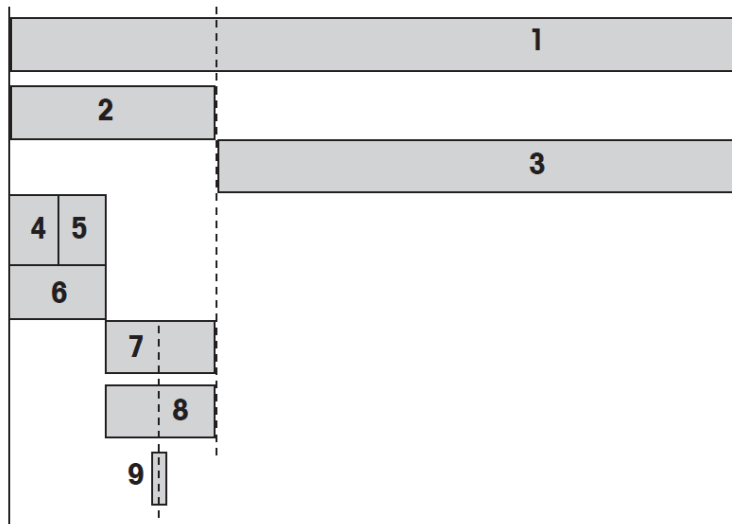

<b>1</b>	Rango de carga máxima de la célula de carga ( $E_{max}$ )
<b>2</b>	Carga previa máxima = Rango de carga máxima <b>1</b> – carga máxima <b>3</b>
<b>3</b>	Carga máxima = Rango de carga máxima <b>1</b> – carga previa máxima <b>2</b>
<b>4</b>	Parte superior de carga previa
<b>5</b>	Plato de pesada de carga previa
<b>6</b>	Carga previa ex fábrica = Carga superior parte previa <b>4</b> + plato de pesada de carga previa <b>5</b>
<b>7</b>	Reserva de carga previa mecánica = Carga previa máxima <b>2</b> – carga previa ex fábrica <b>6</b>
<b>8</b>	El rango de ajuste cero (encendido) puede fijarse. El rango de ajuste cero tiene que encontrarse dentro de la carga previa máxima. El rango de puesta a cero puede ser máx. 18 % de la carga máxima.
<b>9</b>	Rango de puesta a cero $\pm 2$ % de la carga máxima

### 6.5.1 Tabla de cargas previas en kilos

Tipo	Dimensiones [mm]	Carga máx. (3)	Parte superior carga previa (4)	Plato de pesada de carga previa (5)	Carga previa ex fábrica (6)	Reserva de carga previa mecán. (7)	Rango de puesta a cero (8)	Rango de carga máx. (1)
PBA439(x/xx)-QA3	228x228	3	1,04	0,95	1,99	6,01	0,54	11
PBA439(x/xx)-QA6	228x228	6	1,04	0,95	1,99	3,01	1,08	11
PBA439(x/xx)-A3	240x300	3	1,49	1,23	2,72	5,28	0,54	11
PBA439(x/xx)-A6	240x300	6	1,49	1,23	2,72	2,28	1,08	11
PBA439(x/xx)-A15	240x300	15	1,49	1,23	2,72	4,28	2,70	22
PBA439(x/xx)-QB15	305x305	15	1,70	1,51	3,21	3,79	2,70	22
PBA439(x/xx)-QB30	305x305	30	1,70	1,51	3,21	16,79	5,40	50
PBA439(x/xx)-QB60	305x305	60	1,70	1,51	3,21	36,79	10,80	100
PBA439(x/xx)-BB30	300x400	30	2,08	1,86	3,94	16,06	5,40	50
PBA439(x/xx)-BB60	300x400	60	2,08	1,86	3,94	36,06	10,80	100
PBA439(x/xx)-B30	400x500	30	3,45	2,85	6,30	13,70	5,40	50
PBA439(x/xx)-B60	400x500	60	3,45	2,85	6,30	33,70	10,80	100
PBA439(x/xx)-B150	400x500	150	3,45	2,85	6,30	43,70	27,00	200
PBA439(x/xx)-BC60	500x650	60	7,00	5,80	12,80	27,20	10,80	100
PBA439(x/xx)-BC150	500x650	150	7,00	5,80	12,80	35,00	27,00	250
PBA439(x/xx)-BC300	500x650	300	7,00	5,80	12,80	187,20	54,00	500
PBA439(x/xx)-CC60	600x800	60	9,36	11,00	20,36	19,64	10,80	100
PBA439(x/xx)-CC150	600x800	150	9,36	11,00	20,36	79,64	27,00	250
PBA439(x/xx)-CC300	600x800	300	9,36	11,00	20,36	179,64	54,00	500
PBA439(x/xx)-CC600	600x800	600	11,50	14,10	25,60	124,40	108,00	750

## 6.5.2 Tabla de cargas previas en libras

Tipo	Dimensiones [pulgadas]	Carga máx. (3)	Parte superior carga previa (4)	Plato de pesada de carga previa (5)	Carga previa ex fábrica (6)	Reserva de carga previa mecán. (7)	Rango de puesta a cero (8)	Rango de carga máx. (1)
PBA439(x/xx)-QA6	9x9	10	2,29	2,09	4,39	9,86	1,8	24
PBA439(x/xx)-A6	9,5x11,8	10	3,28	2,71	6,00	8,25	1,8	24
PBA439(x/xx)-A15	9,5x11,8	25	3,28	2,71	6,00	17,51	4,5	49
PBA439(x/xx)-QB15	12x12	25	3,75	3,33	7,08	16,42	4,5	49
PBA439(x/xx)-QB30	12x12	50	3,75	3,33	7,08	53,15	9,0	110
PBA439(x/xx)-QB60	12x12	100	3,75	3,33	7,08	113,39	18,0	220
PBA439(x/xx)-BB30	11,8x15,7	50	4,59	4,10	8,69	51,54	9,0	110
PBA439(x/xx)-BB60	11,8x15,7	100	4,59	4,10	8,69	111,78	18,0	220
PBA439(x/xx)-B30	15,7x19,7	50	7,61	6,28	13,89	46,34	9,0	110
PBA439(x/xx)-B60	15,7x19,7	100	7,61	6,28	13,89	106,57	18,0	220
PBA439(x/xx)-B150	15,7x19,7	250	7,61	6,28	13,89	177,04	45,0	441
PBA439(x/xx)-BC60	19,7x25,6	100	15,43	12,79	28,22	92,24	18,0	220
PBA439(x/xx)-BC150	19,7x25,6	250	15,43	12,79	28,22	157,86	45,0	551
PBA439(x/xx)-BC300	19,7x25,6	500	15,43	12,79	28,22	574,09	90,0	1102
PBA439(x/xx)-CC60	23,6x29,5	100	20,64	24,25	44,89	75,58	18,0	220
PBA439(x/xx)-CC150	23,6x29,5	250	20,64	24,25	44,89	256,27	45,0	551
PBA439(x/xx)-CC300	23,6x29,5	500	20,64	24,25	44,89	557,43	90,0	1102
PBA439(x/xx)-CC600	23,6x29,5	1000	25,35	31,09	56,44	597,03	180,0	1653

## 6.6 Accesorios

### Columna

N.º artículo	Designación	Descripción
72229393	Columna abierta 120 mm / 4,7"	Compatible con todos los tamaños de plataforma
72198702	Columna abierta 330 mm / 13"	Compatible con todos los tamaños de plataforma
72198703	Columna abierta 660 mm / 26"	Compatible con todos los tamaños de plataforma
72198704	Columna abierta 900 mm / 35,4"	Compatible con todos los tamaños de plataforma superiores al tamaño A

### Carro de acero inoxidable

N.º artículo	Designación	Descripción
72225939	Carro de acero inoxidable BC	Compatible con plataformas del tamaño BC
72225940	Carro de acero inoxidable CC	Compatible con plataformas del tamaño CC

### Vía de rodillos

N.º artículo	Designación	Descripción
30253326	Vía de rodillos 400 × 500 mm / 15,7" × 19,7" acero inoxidable	Compatible con plataformas del tamaño B. Rodadura hacia el lado corto de la plataforma
30253328	Vía de rodillos 500 × 650 mm / 19,7" × 25,6" acero inoxidable	Compatible con plataformas del tamaño BC. Rodadura hacia el lado corto de la plataforma
30253330	Vía de rodillos 600 × 800 mm / 23,6" × 31,5" acero inoxidable	Compatible con plataformas del tamaño CC. Rodadura hacia el lado corto de la plataforma
30253327	Vía de rodillos 400 × 500 mm / 15,7" × 19,7" acero inoxidable	Compatible con plataformas del tamaño B. Rodadura hacia el lado largo de la plataforma
30253329	Vía de rodillos 500 × 650 mm / 19,7" × 25,6" acero inoxidable	Compatible con plataformas del tamaño BC. Rodadura hacia el lado largo de la plataforma
30253331	Vía de rodillos 600 × 800 mm / 23,6" × 31,5" acero inoxidable	Compatible con plataformas del tamaño CC. Rodadura hacia el lado largo de la plataforma
30640393	Vía de rodillos 400 × 500 mm / 15,7" × 19,7" acero inoxidable	Compatible con el uso en zonas peligrosas
30640394	Vía de rodillos 500 × 650 mm / 19,7" × 25,6" acero inoxidable	Compatible con el uso en zonas peligrosas
30640395	Vía de rodillos 600 × 800 mm / 23,6" × 31,5" acero inoxidable	Compatible con el uso en zonas peligrosas

### Soporte de montaje frontal

N.º artículo	Designación	Descripción
22021062	Soporte de montaje frontal	Compatible con montaje frontal ICS4_9

### Plato de acero inoxidable

N.º artículo	Designación	Descripción
30676769	Plato de acero inoxidable AISI 316 de 240 x 300 mm / 9,5" x 11,8"	Compatible con plataformas del tamaño A

<b>N.º artículo</b>	<b>Designación</b>	<b>Descripción</b>
30676770	Plato de acero inoxidable AISI 316 de 300 x 400 mm / 11,8" x 15,7"	Compatible con plataformas del tamaño BB
30676771	Plato de acero inoxidable AISI 316 de 400 x 500 mm / 15,7" x 19,7"	Compatible con plataformas del tamaño B
30676772	Plato de acero inoxidable AISI 316 de 228 x 228 mm / 9" x 9"	Compatible con plataformas del tamaño QA
30676773	Plato de acero inoxidable AISI 316 de 305 x 305 mm / 12" x 12"	Compatible con plataformas del tamaño QB
30676774	Plato de acero inoxidable AISI 316 de 500 x 650 mm / 19,7" x 25,6"	Compatible con plataformas del tamaño BC
30676775	Plato de acero inoxidable AISI 316, grosor 2,0 mm, 600 x 800 mm / 23,6" x 31,5"	Compatible con plataformas del tamaño CC
30676776	Plato de acero inoxidable AISI 316, grosor 2,5 mm, 600 x 800 mm / 23,6" x 31,5"	Compatible con plataformas del tamaño CC

## 7 Opciones de montaje

El PBA439(x/xx) apoya el montaje sobre un dispositivo estable. En caso de que se requiera la perforación en la plataforma de pesada, siga la plantilla de perforación de abajo.



**NOTA:** Las zonas sombreadas son las zonas en las que está permitido perforar en la plataforma de pesada.

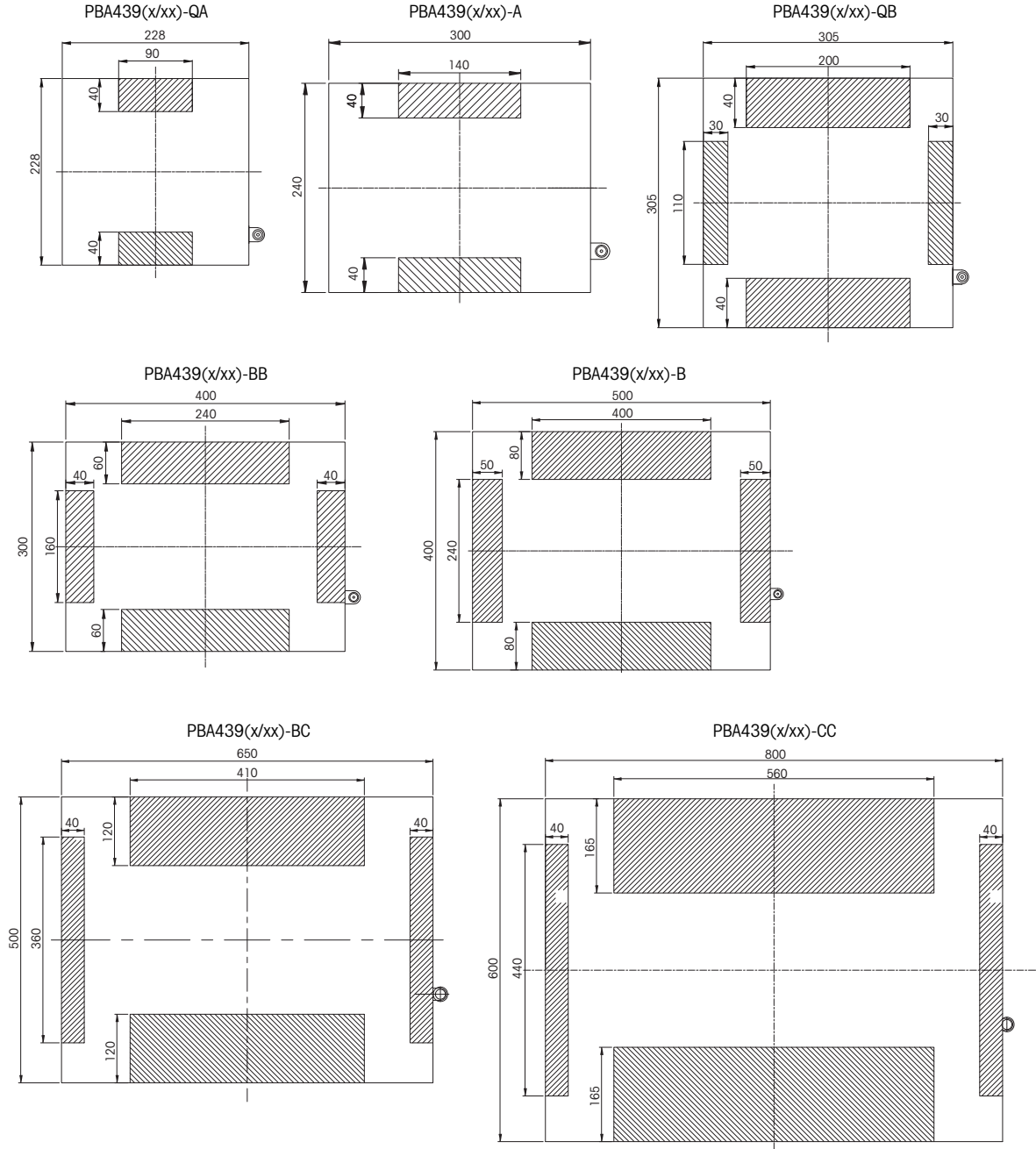

Medido en [mm]



## 8 Apéndice

### 8.1 Etiqueta

<p>IS CL I,II,III DIV 1, GP ABCDEFG T6...T4          Class I, Zone 1, AEx ia IIC T6...T4 Gb          Class II,III, Zone 21, AEx ia IIIC T80°C Db          -40°C ≤ Ta ≤ 60°C T5/T4; -40°C ≤ Ta ≤ 40°C T6          FM21US0076X</p>		<p> II 2G Ex ia IIC T6...T4 Gb          II 2D Ex ia IIIC T80°C Db          -40°C ≤ Ta ≤ 60°C T5/T4          -40°C ≤ Ta ≤ 40°C T6</p>
-----		
<p>IS CL I,II,III DIV 1, GP ABCDEFG T6...T4          Class I, Zone 1, Ex ia IIC T6...T4 Gb          Class II,III, Zone 21, Ex ia IIIC T80°C Db          -40°C ≤ Ta ≤ 60°C T5/T4; -40°C ≤ Ta ≤ 40°C T6          FM21CA0051X</p>		<p>Entity/NIFW for NonIncendive Field Wiring. Entity parameters are shown in drawing 30688074          Mettler-Toledo GmbH, Im Langacher 44, 8606 Greifensee, Switzerland</p>

<p>NI CL I,II,III DIV 2 GP ABCDEFG T6          -40°C ≤ Ta ≤ 60°C          FM21US0076X</p>		<p> II 3G Ex ic IIC T6...T4 Gc          -40°C ≤ Ta ≤ 60°C T5/T4          -40°C ≤ Ta ≤ 40°C T6</p>
-----		
<p>NI CL I,II,III DIV 2 GP ABCDEFG T6...T4          -40°C ≤ Ta ≤ 60°C          Class I, Zone 2, Ex ec IIC T6 Gc;          Class II,III, Zone 22, Ex tc IIIC T80°C Dc          FM21CA0051X</p>		<p> II 3G Ex ec IIC T6 Gc U<sub>rated</sub>=20V          II 3D Ex tc IIIC T80°C Dc I<sub>rated</sub>=50mA          -40°C ≤ Ta ≤ 60°C</p>
-----		
		<p>Entity/NIFW for NonIncendive Field Wiring. Entity parameters are shown in drawing 30688074          Mettler-Toledo GmbH, Im Langacher 44, 8606 Greifensee, Switzerland</p>

## 8.2 Plano de control

<p>FM2IUS0076X IS CL I,II,III DIV 1, GP ABCDEFG T6...T4 Class I, Zone 1, Ex ia IIC T6...T4, Gb Class III, Zone2, Ex ia IIC T80°C Db -40°C Ta60°C T5/T4...T4, Gb (This part is for PBA439x and PBA639x) NI CL I,II,III DIV 2 GP ABCDFG T6...T4 (This part is for PBA439xx and PBA639xx) FM2ICA0051X IS CL I,II,III DIV 1, GP ABCDEFG T6...T4 Class I, Zone 1, Ex ia IIC T6...T4, Gb Class III, Zone2, Ex ia IIC T80°C Db -40°C Ta60°C T5/T4...T4, Gb (This part is for PBA439x and PBA639x) NI CL I,II,III DIV 2 GP ABCDEFG T6...T4 -40°C Ta60°C Class I, Zone 2, Ex ec IIC T6 Gc; Class III, Zone2, Ex tc IIC T80°C Dc (This part is for PBA439xx and PBA639xx)</p>		<p>HAZARDOUS (CLASSIFIED) LOCATION</p> <div style="border: 1px solid black; padding: 5px; margin-bottom: 10px;"> <p>PBA439 and PBA639 ENTITY PARAMETERS VI = 20V II = see table 1 PI = see table 1 (Only for "IS") CI = 6nF (See Note 4) LI = 30µH (See Note 4)</p> </div> <p>HAZARDOUS (CLASSIFIED) LOCATION</p> <div style="border: 1px solid black; padding: 5px; margin-bottom: 10px;"> <p>PBA439 and PBA639 ENTITY PARAMETERS VI = 20V II = see table 1 PI = see table 1 (Only for "IS") CI = 6nF (See Note 4) LI = 30µH (See Note 4)</p> </div> <p>NON HAZARDOUS LOCATION</p> <div style="border: 1px solid black; padding: 5px; margin-bottom: 10px;"> <p>FM APPROVED ASSOCIATED APPARATUS WITH ENTITY CONCEPT PARAMETERS Voc ≤ VI Isc ≤ II Po ≤ PI (Only for "IS") Ca ≥ Ci+Cc (See Note 5) La ≥ Li+Lc (See Note 5)</p> </div> <p>SCALE STRUCTURE TO BE CONNECTED TO SYSTEM SAFETY GROUND (See Note 2)</p>
---	--	---



### 8.3 Plano de instalación

#### Hazardous (Classified) Location

IP67 II 3G Ex ic IIC T6...T4 Gc  
-40°C ≤ T<sub>a</sub> ≤ 60°C T5/T4; -40°C ≤ T<sub>a</sub> ≤ 40°C T6

II 3G Ex ec IIC T6 Gc -40°C ≤ T<sub>a</sub> ≤ 60°C T6  
II 3D Ex tc IIC T80°C Dc  
FM21UKEX0080X  
FM21ATEX0025X IECEX FMG21.0003X

---

II 2G Ex ia IIC T6...T4 Gb  
-40°C ≤ T<sub>a</sub> ≤ 60°C T5/T4; -40°C ≤ T<sub>a</sub> ≤ 40°C T6

II 2D Ex ia IIC T80°C Db  
FM21UKEX0079X  
FM21ATEX0003X IECEX FMG21.0003X

**Approval Mark**

THIS ITEM IS PART OF AGENCY APPROVED PRODUCT

Metrology  
 Safety  
 Ex

DO NOT CHANGE DOCUMENT WITHOUT APPROPRIATE APPROVAL

SLP84x Load Cell

U<sub>i</sub> = 20V  
I<sub>i</sub> = see table 2  
P<sub>i</sub> = see table 2  
C<sub>i</sub> = 6nF  
L<sub>i</sub> = 30uH

Ex Approved Associated Apparatus with Entity Concept Parameters

U<sub>o</sub> ≤ U<sub>i</sub>  
I<sub>o</sub> ≤ I<sub>i</sub>  
P<sub>o</sub> ≤ P<sub>i</sub>  
C<sub>o</sub> ≥ C<sub>c</sub>+C<sub>i</sub>  
L<sub>o</sub> ≥ L<sub>c</sub>+L<sub>i</sub>

Scale structure (attached to load cell) to be connected to system safety ground. See Note.

**NOTES:**

- The resistance between all safety ground connections and the system grounding electrode must not exceed 1ohm.
- Installation shall be in accordance with relevant electrical installation standards (Being shown in Table 1) in hazardous areas (other than mines).
- Entity Parameters C<sub>i</sub> And L<sub>i</sub> Include Maximum Load Cell Cable Length Of 30m
- Entity Parameters C<sub>c</sub> and L<sub>c</sub> is the capacitance and inductance of cable connect between load cell and the associated apparatus.
- In an explosive atmosphere caused by air/dust mixtures, the loose ends of the cable shall be connected outside the hazardous area or in a suitable enclosure with a degree of protection of at least IP6X in accordance with EN 60529.
- For the application of Ex ec, Ex tc: U<sub>rated</sub>=20V, I<sub>rated</sub>=50mA.
- Installation of load cell needs to be done in such way that enclosure welded caps are physically obstructed from any possible impact.
- ⚠ Not following these instructions will jeopardize the explosion safety.
- For the application of Ex ec, The equipment shall only be used in an area of at least pollution degree 2, as defined in IEC 60664-1.

**Table 1**

EN60079-0: 2018	EN60079-14: 2014	EN60079-11: 2012	EN60079-31: 2014
EN61241-14: 2004	EN60079-31: 2013	EN60079-7: 2015	IEC60079-31: 2013
IEC 60079-0-2017	IEC 60079-11-2011	IEC 60079-14-2013	IEC60079-7: 2015

**Table 2**

Temperature class	P <sub>i</sub>	I <sub>i</sub>
T4	2.1W	800mA
T5	1.2W	600mA
T6	0.6W	600mA

Mettler-Toledo GmbH, Im Langacher 44, 8606 Greifensee, Switzerland  
Mettler-Toledo Ltd. 64 Boston Rd. Leicester, LE4 1AW, United Kingdom

D	update drawing status	Wang Jianwen	Liu Yuchun				2021-7-26
C	removed Ex nA of note 6	Wang Jianwen	Liu Yuchun				2021-1-15
REV / CHG	ZONE DESCRIPTION	BY	APPVD	AGENCY	E.R. No.	DATE	
<b>RECORD OF CHANGES</b>							
<b>METTLER TOLEDO</b>		MTCZ	Drawn	Wang JW	2020/05/11	Scale	1:1
		CN-213022 ChangZhou	Change			Format	mt_A4
Refer to protection notice ISO 16016 / Schutzvermerk ISO 16016 beachten		Note	-			Replaces	-
Description 防爆安装图 SLP84X		ERP NO.	30555321			ERP Rev	D
External Design No.: D000644580		External Design Rev.: D	Status: Approved	Mass:	Units: mm	1/1	

AutoCAD Mechanical Template V0.2

es



# METTLER TOLEDO Service

Congratulazioni per aver scelto la qualità e la precisione di METTLER TOLEDO. L'utilizzo corretto di questa nuova apparecchiatura in accordo con le istruzioni riportate in questo Manuale e interventi regolari di calibrazione e manutenzione a cura del nostro team del servizio assistenza appositamente addestrato in fabbrica, garantiscono un funzionamento affidabile e accurato e proteggono il vostro investimento. Contattateci: insieme definiremo un contratto di assistenza su misura per le vostre esigenze e per il vostro budget. Ulteriori informazioni sono disponibili alla pagina web ► [www.mt.com/service](http://www.mt.com/service).

Per ottenere il massimo dal vostro investimento dovete:

- 1 **Registrare il prodotto:** Vi invitiamo a registrare il prodotto alla pagina web [www.mt.com/productregistration](http://www.mt.com/productregistration) così potremo tenervi sempre informati sui miglioramenti, gli aggiornamenti e le segnalazioni importanti riguardanti il vostro prodotto.
- 2 **Per interventi di manutenzione/assistenza, contattare METTLER TOLEDO:** Il valore di una misurazione è proporzionale alla sua precisione – una bilancia fuori specifica può comportare una diminuzione della qualità e dei profitti e aumentare la responsabilità. Un servizio tempestivo da parte di METTLER TOLEDO garantirà precisione e ottimizzerà i tempi medi di funzionamento e la durata dell'apparecchiatura.
  - ➔ **Installazione, configurazione, integrazione e addestramento:** I nostri rappresentanti dell'assistenza sono esperti di strumenti di pesata e sono addestrati in fabbrica. Vogliamo essere certi che il vostro strumento di pesata sia pronto per la produzione in maniera efficace rispetto ai costi e tempestiva e che il personale sia ben addestrato.
  - ➔ **Documentazione relativa alla calibrazione iniziale:** L'ambiente di installazione e i requisiti di applicazione sono specifici per ogni bilancia industriale, per cui è necessario testarne e certificarne le prestazioni. I nostri interventi e certificati di calibrazione documentano la precisione per garantire qualità produttiva e fornire un sistema di registrazione e qualificazione delle prestazioni.
  - ➔ **Manutenzione periodica della calibrazione:** Un Accordo in materia di Interventi di Calibrazione garantisce in maniera costante la qualità del vostro processo di pesata e la tenuta della documentazione aggiornata attestante il rispetto dei requisiti. Offriamo una pluralità di programmi di assistenza messi a punto per soddisfare le vostre esigenze e salvaguardare il vostro budget.



# Sommario

<b>1</b>	<b>Istruzioni di sicurezza</b>	<b>3</b>
1.1	Usò previsto .....	3
1.2	Utilizzo improprio.....	3
1.3	Avvertenze di sicurezza .....	3
1.4	Condizioni d'uso specifiche.....	3
<b>2</b>	<b>Introduzione</b>	<b>4</b>
2.1	Gamma di prodotti.....	4
2.2	Generalità sul presente manuale.....	4
2.3	Ulteriore documentazione.....	4
<b>3</b>	<b>Installazione e funzionamento</b>	<b>5</b>
3.1	Collegamento della piattaforma di pesatura al terminale di pesatura .....	5
3.2	Livellamento.....	6
3.3	Collegamento equipotenziale.....	6
3.4	Verifica della piattaforma di pesatura.....	6
3.5	Usò della piattaforma di pesatura .....	7
3.6	Installazione, configurazione, assistenza e riparazione .....	7
<b>4</b>	<b>Manutenzione</b>	<b>8</b>
4.1	Note sulla pulizia.....	8
4.2	Trattamento successivo .....	8
4.3	Smaltimento .....	8
<b>5</b>	<b>Riparazione</b>	<b>9</b>
<b>6</b>	<b>Dati tecnici e limiti di esercizio</b>	<b>10</b>
6.1	Intervallo massimo di verifica della bilancia.....	10
6.2	Carico massimo ammissibile.....	10
6.3	Dati tecnici della cella di carico .....	11
6.3.1	Omologazione Ex.....	11
6.3.2	Standard di conformità della cella di carico .....	11
6.4	Dimensioni .....	13
6.5	Informazioni sulla capacità di precarico .....	14
6.5.1	Tabella del precarico in chilogrammi.....	15
6.5.2	Tabella del precarico in libbre.....	16
6.6	Accessori.....	17
<b>7</b>	<b>Possibilità di montaggio</b>	<b>19</b>
<b>8</b>	<b>Appendice</b>	<b>20</b>
8.1	Etichetta.....	20
8.2	Schema di controllo .....	21
8.3	Disegno di installazione .....	22



# 1 Istruzioni di sicurezza

## 1.1 Uso previsto

Le piattaforme di pesatura PBA439(x/xx) sono parte di un sistema di pesatura formato da un terminale di pesatura METTLER TOLEDO con funzione di indicatore e da almeno una piattaforma di pesatura.

- Usare la piattaforma di pesatura per pesare oggetti come descritto nel presente manuale.
- La piattaforma di pesatura è prevista per il solo uso all'interno di un edificio.
- Solo la piattaforma di pesatura PBA439x/xx è adatta per l'uso in un ambiente pericoloso come specificato nel seguito.
- Qualsiasi altra tipologia d'uso è considerata non conforme.

### Metrologia legale

- Per l'uso nella metrologia legale utilizzare solo piattaforme di pesatura approvate.
- Per l'uso nella metrologia legale, la società operativa è responsabile dell'osservanza di tutti i requisiti nazionali concernenti i pesi e le misure.
- Si prega di contattare l'organizzazione di assistenza METTLER TOLEDO per domande relative all'uso in applicazioni legali per il commercio.

## 1.2 Utilizzo improprio

- Non utilizzare il terminale di pesatura se non per operazioni di pesatura.
- Non utilizzare la piattaforma di pesatura in ambienti diversi da quelli specificati nella --- MISSING LINK ---.
- Non modificare la piattaforma di pesatura.
- Non utilizzare il terminale di pesatura oltre i limiti delle specifiche tecniche.
- Non utilizzare la piattaforma di pesatura per immagazzinare merci.
- Evitare di far cadere merci sulla piattaforma di pesatura.

## 1.3 Avvertenze di sicurezza

- Solo il personale formato e qualificato da METTLER TOLEDO può installare e mantenere la piattaforma di pesatura.
- Prestare attenzione durante il trasporto o il sollevamento di dispositivi pesanti.
- Scollegare sempre la piattaforma di pesatura dall'alimentazione elettrica prima di installare, riparare, pulire o eseguire la manutenzione.
- Il cavo di collegamento non deve essere scollegato dal terminale di pesatura mentre è sotto tensione.
- Assicurarsi che la piattaforma di pesatura abbia raggiunto la temperatura ambiente prima di collegare l'alimentazione elettrica.
- Le piattaforme di pesatura con protezione antideflagrante PBA439x/xx sono approvate per il funzionamento nelle seguenti aree pericolose:
  - ATEX/IECEx Categoria 2, Categoria 3, gas/polvere (Zona 1/21, Zona 2/22)
  - cFMus, Classe I,II,III, Div. 1, Div. 2
- Sussiste un maggior rischio di lesioni e danni quando le piattaforme di pesatura vengono utilizzate in aree pericolose! Prestare particolare attenzione quando si lavora in tali aree.
- Nel caso della piattaforma di pesatura PBA439x/xx, utilizzare solo passacavi adatti e approvati per aree pericolose per l'inserimento del cavo della cella di pesatura nel terminale di pesatura.
- Le piattaforme di pesatura con protezione antideflagrante possono essere utilizzate in aree pericolose solo in combinazione con terminali di pesatura con approvazione e specifiche dell'interfaccia appropriate.

## 1.4 Condizioni d'uso specifiche

- In un'atmosfera esplosiva causata dall'umidità dell'aria/della polvere, le estremità libere del cavo devono essere collegate all'esterno dell'area pericolosa o in una custodia adeguata con un grado di protezione di almeno IP6X in conformità con IEC/EN 60529.

## 2 Introduzione

### 2.1 Gamma di prodotti

Il presente manuale focalizza sulla serie di prodotti PBA439(x/xx).

La serie PBA439(x/xx) offre tutta una varietà di piattaforme di pesatura per soddisfare le esigenze del cliente. È omologabile e offre varie dimensioni e capacità

Tipo	Materiale del piano di carico	Materiale del telaio della bilancia	Design della cella di carico	Protezione IP ambientale	Approvazione per ambienti pericolosi
PBA439	Acciaio inossidabile AISI304	Acciaio inossidabile AISI304	Acciaio inossidabile, sigillatura ermetica	Asciutto, bagnato, IP68/IP69K	-
PBA439x					Zona 1/21, Div 1
PBA439xx					Zona 2/22, Div 2

### 2.2 Generalità sul presente manuale



Il presente manuale contiene tutte le informazioni per l'operatore del prodotto.

- Leggere attentamente questo manuale prima dell'uso.
- Conservare questo manuale per la consultazione futura.
- Consegnare questo manuale a qualsiasi futuro proprietario o utente del prodotto.

### 2.3 Ulteriore documentazione

Oltre al presente manuale, dal sito ► [www.mt.com](http://www.mt.com) si può scaricare la seguente documentazione:

- Prospetto
- Informazioni sull'installazione (per personale qualificato sotto il controllo della società operativa)
- Documenti di omologazione

#### Scaricamento di certificati

I certificati USA, Canada, ATEX, UKEX e IECEx possono essere scaricati da

► <https://www.mt.com/us/en/home/search/compliance.html/compliance/>.



### 3 Installazione e funzionamento

#### 3.1 Collegamento della piattaforma di pesatura al terminale di pesatura

Le piattaforme di pesatura PBA439(x/xx) sono progettate per l'uso con terminali di pesatura analogici METTLER TOLEDO.

- 1 Inserire il cavo della piattaforma di pesatura nel passacavo portandolo all'interno del terminale di pesatura.
- 2 Collegare il cavo della piattaforma di pesatura alla morsettiera del terminale di pesatura come indicato nella tabella seguente.

Segnale	Colore del conduttore	Connettore
SIG+	Bianco	
SIG-	Rosso	
EXC+	Verde	
EXC-	Nero	
SEN+	Giallo	
SEN-	Blu	



#### **AVVERTENZA**

**La schermatura del cavo deve essere collegata a terra.**

#### Avvertenze di sicurezza per i collegamenti

- Quando si collega la piattaforma di pesatura all'interno di un'area pericolosa, attenersi rigorosamente ai requisiti indicati nello schema di controllo in [Appendice ► pagina 20].
- Si prega di verificare le condizioni speciali per l'uso sicuro nei disegni e nei certificati in [Appendice ► pagina 20].
- La schermatura del cavo è collegata all'elemento a molla della cella di carico (del corpo della cella di carico). Si prega di considerare il collegamento appropriato tra cella di carico e terminale (o scatola di giunzione) a seconda dello scenario di installazione.
- La resistenza tra tutti i collegamenti di messa a terra di sicurezza e l'elettrodo di messa a terra del sistema non deve superare il valore di 1 ohm.
- L'installazione deve essere conforme agli standard di installazione elettrica pertinenti.
- La mancata osservanza di queste istruzioni compromette la sicurezza contro le esplosioni.

### 3.2 Livellamento

Solo una piattaforma di pesatura esattamente orizzontale fornisce risultati di pesatura esatti. La piattaforma di pesatura deve essere livellata durante l'installazione iniziale e ogni volta che la sua posizione viene modificata.

- 1 Ruotare i piedini regolabili della piattaforma di pesatura fino a portare la bolla d'aria della livella all'interno del cerchio interno.
- 2 Serrare i controdati dei piedini regolabili.

👉 Scansionare il codice QR per richiamare il v

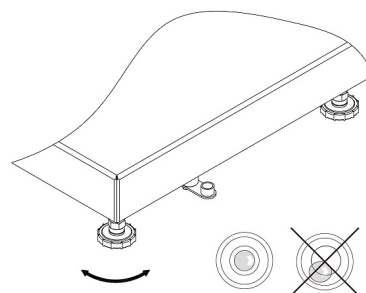

### 3.3 Collegamento equipotenziale

Il collegamento equipotenziale per le piattaforme di pesatura PBA439x/xx è montato in fabbrica. Il cablaggio deve essere installato da un elettricista professionista presso il cliente. L'assistenza METTLER TOLEDO svolge solo una funzione di monitoraggio e consulenza. Connettere il collegamento equipotenziale (PA) di tutti i dispositivi (piattaforma di pesatura e terminale di pesatura) secondo le disposizioni e gli standard nazionali. Nel processo, assicurarsi che tutti gli alloggiamenti dei dispositivi siano collegati allo stesso potenziale tramite il terminale PA.

#### Nota

L'apparecchiatura è protetta contro la folgorazione elettrica secondo IEC60950, Classe II.

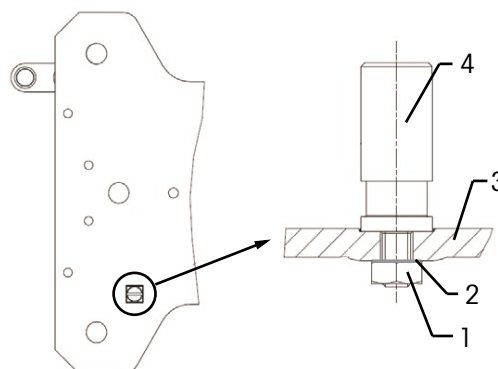

- 1 - Controdado esagonale, M4 KEPS
- 2 - Rondella
- 3 - Telaio di base
- 4 - Terminale per il collegamento equipotenziale, coppia 3,5 Nm

Numero d'ordine del kit per il collegamento equipotenziale:  
72237321

### 3.4 Verifica della piattaforma di pesatura

#### Verifica del funzionamento

- 1 Assicurarsi che la piattaforma di pesatura sia collegata a un terminale di pesatura e che il terminale di pesatura sia acceso.
- 2 Assicurarsi che la piattaforma di pesatura sia scarica e che il display del terminale di pesatura indichi 0.
- 3 Caricare la piattaforma di pesatura. Il terminale di pesatura deve indicare un valore diverso da 0.
- 4 Scaricare la piattaforma di pesatura. Il terminale di pesatura deve tornare a 0.

#### Test di verifica

Per il test di verifica fare riferimento al manuale utente del terminale di pesatura collegato. Se il sigillo di verifica è spezzato, la verifica non è più valida.

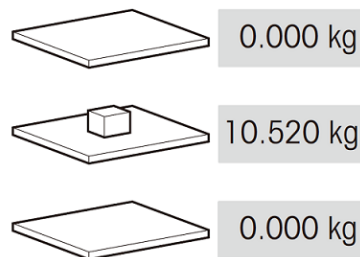

### 3.5 Uso della piattaforma di pesatura

Per ottenere i migliori risultati di pesatura, osservare quanto segue:

- Assicurarsi che il piano di carico sia posizionato correttamente.

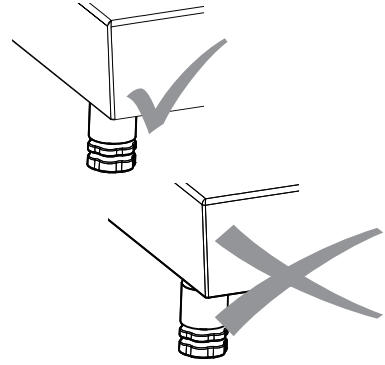

- Per ottenere i migliori risultati di pesatura, posizionare il campione da pesare sempre nella stessa posizione sulla piattaforma di pesatura.

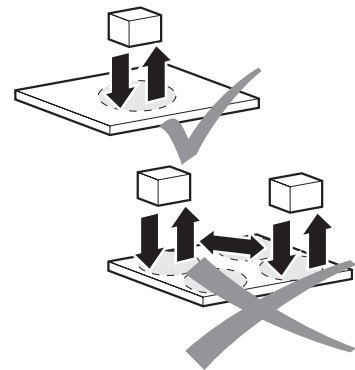

- Evitare processi abrasivi e usuranti.

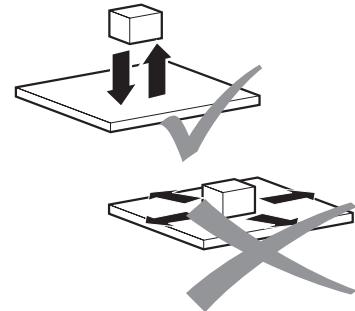

- Evitare la caduta di carichi, urti e impatti laterali.

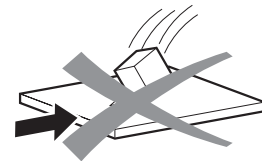

### 3.6 Installazione, configurazione, assistenza e riparazione

Per l'installazione, la configurazione, l'assistenza e la riparazione chiamare il servizio assistenza METTLER TOLEDO.

## 4 Manutenzione

### 4.1 Note sulla pulizia

#### Nota

##### Danni alla piattaforma di pesatura dovuti all'uso improprio di detersivi.

- Utilizzare solo disinfettanti e detersivi secondo le istruzioni del fabbricante.
- Non utilizzare molto altamente acidi, molto alcalini o molto clorurati. Evitare sostanze con un valore del pH alto o basso, altrimenti sussisterebbe un maggiore pericolo di corrosione.
- Prestare particolare attenzione durante la pulizia della cella di carico.

#### Procedura di pulizia

- Rimuovere regolarmente lo sporco e i depositi dall'esterno e dall'interno della piattaforma di pesatura.
  - ➔ La procedura dipende sia dal tipo di superficie che dalle condizioni ambientali del luogo di installazione.

##### Pulizia in ambiente umido (versioni in acciaio inossidabile)

- Utilizzare un getto d'acqua alla temperatura massima di 80 °C / 176 °F e alla pressione massima di 80 bar; distanza minima 40 cm / 16".
- Utilizzare detersivi per la casa.

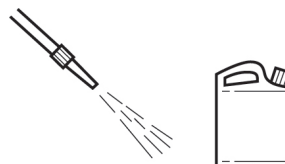

##### Pulizia in ambiente corrosivo (versioni in acciaio inossidabile)

- Utilizzare un getto d'acqua.
  - Pulizia interna**, cella di carico, piano di carico aperto: temperatura massima 60 °C / 140 °F, pressione massima 2 bar, distanza minima 40 cm / 16".
  - Pulizia esterna**, piano di carico chiuso: temperatura massima 80 °C / 176 °F, pressione massima 80 bar, distanza minima 40 cm / 16".
- Rimuovere le sostanze corrosive a intervalli regolari.
- Utilizzare solo disinfettanti e detersivi secondo le specifiche e le istruzioni del fabbricante

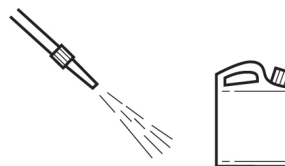

### 4.2 Trattamento successivo

Per proteggere la bilancia, eseguire il seguente trattamento:

- Sciacquare la bilancia con acqua pulita e rimuovere completamente il detersivo.
- Asciugare la bilancia con un panno che non lascia lanugine.
- Nelle bilance in acciaio inossidabile, trattare l'interno e l'esterno con un olio idoneo per alimenti.

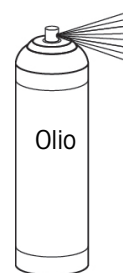

### 4.3 Smaltimento

In conformità a quanto stabilito dalla Direttiva Europea 2012/19/UE sui rifiuti di apparecchiature elettriche ed elettroniche (RAEE), il presente strumento non può essere smaltito tra i rifiuti domestici. Tale presupposto resta valido anche per i Paesi al di fuori dei confini della UE, conformemente alle norme nazionali vigenti.

Smaltire il prodotto in conformità con le disposizioni locali, presso un punto di raccolta specifico per apparecchiature elettriche ed elettroniche. Per qualsiasi chiarimento, rivolgersi agli enti preposti o al rivenditore dell'apparecchiatura stessa. Nel caso in cui si debba cedere lo strumento a terzi, occorre allegare il contenuto della normativa citata.



## 5 Riparazione

Questa apparecchiatura è certificata per l'uso in aree pericolose, per cui non sono consentite modifiche. Le riparazioni devono essere eseguite solo da personale specificamente addestrato per la riparazione di questa apparecchiatura.

## 6 Dati tecnici e limiti di esercizio

### 6.1 Intervallo massimo di verifica della bilancia

Intervallo max. di verifica della bilancia [e] / OIML	Capacità							
	3 kg	6 kg	15 kg	30 kg	60 kg	150 kg	300 kg	600 kg
1 x 3000e Max / e [kg]	3 / 0.001	6 / 0.002	15 / 0.005	30 / 0.01	60 / 0.02	150 / 0.05	300 / 0.1	600 / 0.2

Intervallo max. di verifica della bilancia [d] / NTEP	Capacità							
	-	10 lb	25 lb	50 lb	100 lb	250 lb	500 lb	1000 lb
1 x 5000d Max / d [lb]	-	10 / 0.002	25 / 0.005	50 / 0.01	100 / 0.02	250 / 0.05	500 / 0.1	1000 / 0.2

### 6.2 Carico massimo ammissibile

Tutte le piattaforme di pesatura sono dotate di protezione dal sovraccarico. Grazie al robusto design della bilancia, occasionalmente si può superare la capacità nominale della piattaforma senza danni. Il carico statico massimo di sicurezza non deve mai essere superato.

- Osservare i seguenti limiti operativi.

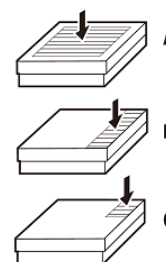

Modello	A - carico centrale	B - carico laterale	C - carico sull'angolo
PBA439(x/xx)-QA	40 kg / 80 lb	30 kg / 60 lb	15 kg / 30 lb
PBA439(x/xx)-A	40 kg / 80 lb	30 kg / 60 lb	15 kg / 30 lb
PBA439(x/xx)-QB	100 kg / 200 lb	70 kg / 140 lb	35 kg / 70 lb
PBA439(x/xx)-BB	100 kg / 200 lb	70 kg / 140 lb	35 kg / 70 lb
PBA439(x/xx)-B	200 kg / 400 lb	140 kg / 280 lb	75 kg / 150 lb
PBA439(x/xx)-BC	400 kg / 800 lb	300 kg / 600 lb	150 kg / 300 lb
PBA439(x/xx)-CC	700 kg / 1400 lb	400 kg / 800 lb	200 kg / 400 lb



#### **AVVERTENZA**

**Evitare la caduta di carichi, i carichi impulsivi e gli impatti laterali.**

## 6.3 Dati tecnici della cella di carico

Tensione di uscita nominale	mV/V	1,8 ± 0,2
Resistenza d'ingresso	Ω	384 ± 15
Resistenza d'uscita	Ω	350 ± 4
Tensione raccomandata	V (DC / AC)	5 - 15
Max. tensione eccitata	V (DC / AC)	20
Guaina del cavo	-	PVC
Classificazione IP	-	IP68/IP69K

### 6.3.1 Omologazione Ex

Questa sezione riguarda soltanto gli aspetti Ex rilevanti del prodotto.

La cella di carico SLP84x(x=6,7,8) possiede:

Certificato ATEX	FM21ATEX0003X, FM21ATEX0025X
Certificato UK	FM21UKEX0079X, FM21UKEX0080X
Certificato IECEx	IECEx FMG21.0003X
Certificato USA	FM21US0005X
Certificato canadese	FM21CA0002X

Per i certificati sopra elencati e i relativi schemi di installazione si rimanda all'[Appendice ► pagina 20].

### 6.3.2 Standard di conformità della cella di carico

#### Standard USA

Titolo	Numero	Data di rilascio
Apparecchiature elettriche per l'uso in luoghi pericolosi (classificati) - Requisiti generali	FM Classe 3600	2018
Apparecchio a sicurezza intrinseca e apparecchi associati per l'uso in aree di Classe I, II e III, Divisione 1, aree pericolose (classificate)	FM Classe 3610	2021
Apparecchiature elettriche a prova di incendio per l'uso in aree di Classe I e II, Divisione 2 e Classe III, Divisioni 1 e 2, aree pericolose (classificate)	FM Classe 3611	2021
Apparecchiature elettriche per la misurazione, il controllo e l'uso in laboratorio	FM Classe 3810	2021
Atmosfere esplosive - Parte 0: Equipaggiamento - Requisiti generali	ANSI/UL 60079-0	2019
Atmosfere esplosive - Parte 11: Protezione delle apparecchiature a sicurezza intrinseca "i"	ANSI/ISA 60079-11	2014
Apparecchiature elettriche a prova di incendio per l'uso in aree pericolose (classificate) di Classe I e II, Divisione 2 e Classe III, Divisioni 1 e 2	ANSI/UL 121201	2017
Requisiti di sicurezza per apparecchiature elettriche per la misurazione, il controllo e l'uso in laboratorio - Parte 1: Requisiti generali	ANSI/UL 61010-1	2012
Gradi di protezione offerti dagli involucri (codice IP)	ANSI/IEC 60529	2020

#### Standard canadesi

Titolo	Numero	Data di rilascio
Apparecchiature elettriche a prova di incendio per l'uso in aree pericolose di Classe I, Divisione 2	CSA C22.2 No. 213	2017
Atmosfere esplosive - Parte 0: Equipaggiamento - Requisiti generali	CAN/CSA-C22.2 No. 60079-0	2019
Atmosfere esplosive - Parte 11: Protezione delle apparecchiature a sicurezza intrinseca "i"	CAN/CSA-C22.2 No. 60079-11	2014

Titolo	Numero	Data di rilascio
Atmosfere esplosive - Parte 7: Protezione delle apparecchiature a sicurezza aumentata "e"	CAN/CSA-C22.2 No. 60079-7	2018
Atmosfere esplosive - Parte 31: Protezione contro l'accensione delle polveri mediante involucro "t"	CAN/CSA-C22.2 No. 60079-31	2015
Requisiti di sicurezza per apparecchiature elettriche per la misurazione, il controllo e l'uso in laboratorio - Parte 1: Requisiti generali	CSA C22.2 No. 61010-1	2012
Gradi di protezione offerti dagli involucri (codice IP)	CSA C22.2 No. 60529	2016

### Standard IECEx

Titolo	Numero	Data di rilascio
Atmosfere esplosive - Parte 0: Equipaggiamento - Requisiti generali	IEC 60079-0	2017
Atmosfere esplosive - Parte 11: Protezione delle apparecchiature a sicurezza intrinseca "i"	IEC 60079-11	2011
Atmosfere esplosive - Parte 7: Protezione delle apparecchiature a sicurezza aumentata "e"	IEC 60079-7	2017
Atmosfere esplosive - Parte 31: Protezione contro l'accensione delle polveri mediante involucro "t"	IEC 60079-31	2013
Gradi di protezione offerti dagli involucri (codice IP)	IEC 60529	2013

### Standard ATEX

Titolo	Numero	Data di rilascio
Atmosfere esplosive - Parte 0: Equipaggiamento - Requisiti generali	EN IEC 60079-0	2018
Atmosfere esplosive - Parte 11: Protezione delle apparecchiature a sicurezza intrinseca "i"	EN 60079-11	2012
Atmosfere esplosive - Parte 7: Protezione delle apparecchiature a sicurezza aumentata "e"	EN 60079-7	2015 +A1:2018
Atmosfere esplosive - Parte 31: Protezione contro l'accensione delle polveri mediante involucro "t"	EN 60079-31	2014
Gradi di protezione offerti dagli involucri (codice IP)	EN 60529	1991 + A1:2000 + A2:2013

### Standard UKEX

Titolo	Numero	Data di rilascio
Atmosfere esplosive - Parte 0: Equipaggiamento - Requisiti generali	EN IEC 60079-0	2018
Atmosfere esplosive - Parte 11: Protezione delle apparecchiature a sicurezza intrinseca "i"	EN 60079-11	2012
Atmosfere esplosive - Parte 7: Protezione delle apparecchiature a sicurezza aumentata "e"	EN 60079-7	2015 +A1:2018
Atmosfere esplosive - Parte 31: Protezione contro l'accensione delle polveri mediante involucro "t"	EN 60079-31	2014
Gradi di protezione offerti dagli involucri (codice IP)	EN 60529	1991 + A1:2000 + A2:2013



## 6.4 Dimensioni

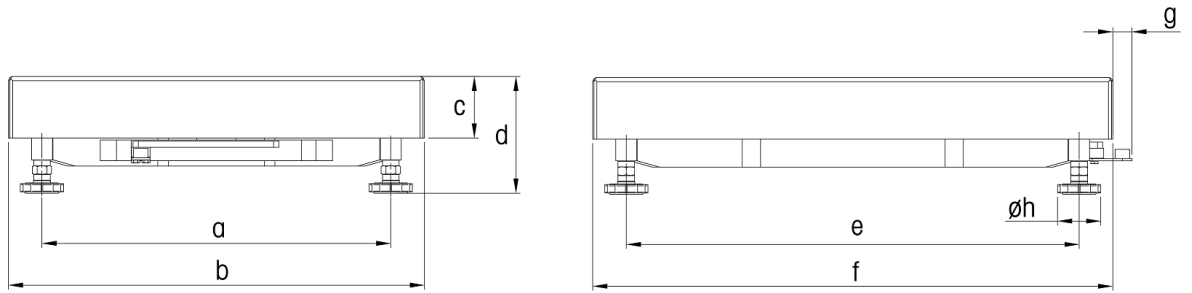

Dimensioni		a	b	c	d *	e	f	g	h
PBA439(x/xx)-QA	mm	163	228	56	85,6	163	228	21	42
	pollici	6,42	8,98	2,20	3,37	6,42	8,98	0,83	1,65
PBA439(x/xx)-A	mm	175	240	56	85,6	235	300	21	42
	pollici	6,89	9,45	2,20	3,37	9,25	11,81	0,83	1,65
PBA439(x/xx)-QB	mm	240	305	57	96,6	253	305	18	42
	pollici	9,45	12,01	2,24	3,8	9,96	12,01	0,71	1,65
PBA439(x/xx)-BB	mm	235	300	57	96,6	335	400	18	42
	pollici	9,25	11,81	2,24	3,8	13,19	15,75	0,71	1,65
PBA439(x/xx)-B	mm	335	400	59	100,1	435	500	18	42
	pollici	13,19	15,75	2,32	3,94	17,13	19,69	0,71	1,65
PBA439(x/xx)-BC	mm	437	500	73	106,8	584	650	17	42
	pollici	17,20	19,69	2,87	4,2	22,99	25,59	0,67	1,65
PBA439(x/xx)-CC	mm	503	600	85	128,3	724	800	18	42
	pollici	19,80	23,62	3,35	5,05	28,5	31,50	0,71	1,65

\* 1) d = altezza minima della piattaforma. Con i piedini regolabili, l'altezza della piattaforma può aumentare al massimo di 10 mm / 0,39 pollici.

2) Con l'opzione kit igienico, l'altezza minima della piattaforma (d) aumenta di 12 mm / 0,47 pollici.

## 6.5 Informazioni sulla capacità di precarico

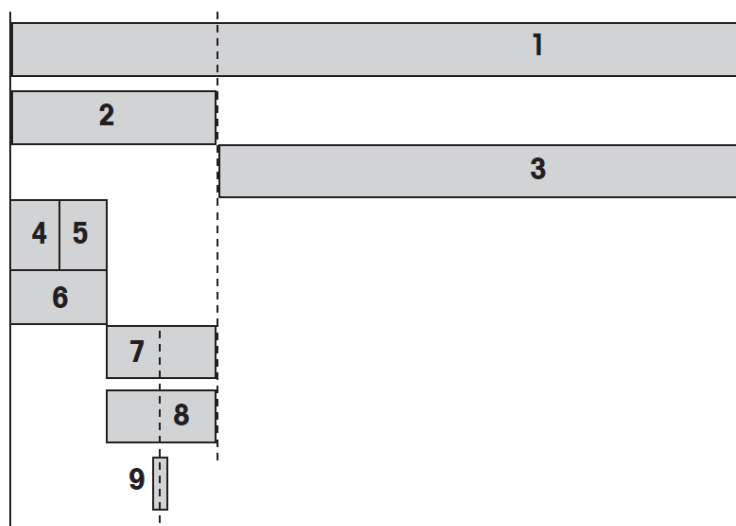

<b>1</b>	Intervallo di carico massimo della cella di carico ( $E_{max}$ )
<b>2</b>	Precarico massimo = intervallo di carico massimo <b>1</b> – carico massimo <b>3</b>
<b>3</b>	Carico massimo = intervallo di carico massimo <b>1</b> – precarico massimo <b>2</b>
<b>4</b>	Precarico sezione superiore
<b>5</b>	Precarico piatto di pesatura
<b>6</b>	Precarico da fabbrica = precarico sezione superiore <b>4</b> + precarico piatto di pesatura <b>5</b>
<b>7</b>	Riserva di precarico meccanico = precarico massimo <b>2</b> + precarico da fabbrica <b>6</b>
<b>8</b>	È possibile impostare l'intervallo di azzeramento (accensione). L'intervallo di azzeramento deve rientrare nel precarico massimo. L'intervallo di azzeramento può essere pari a max. il 18 % del carico massimo.
<b>9</b>	Intervallo di azzeramento $\pm 2$ % del carico massimo

## 6.5.1 Tabella del precarico in chilogrammi

Tipo	Dimensioni [mm]	Carico max. (3)	Precarico sezione sup. (4)	Precarico piatto di pesatura (5)	Precarico da fabbrica (6)	Riserva di precarico mecc. (7)	Intervallo di azzeramento (8)	Intervallo di carico max. (1)
PBA439(x/xx)-QA3	228x228	3	1,04	0,95	1,99	6,01	0,54	11
PBA439(x/xx)-QA6	228x228	6	1,04	0,95	1,99	3,01	1,08	11
PBA439(x/xx)-A3	240x300	3	1,49	1,23	2,72	5,28	0,54	11
PBA439(x/xx)-A6	240x300	6	1,49	1,23	2,72	2,28	1,08	11
PBA439(x/xx)-A15	240x300	15	1,49	1,23	2,72	4,28	2,70	22
PBA439(x/xx)-QB15	305x305	15	1,70	1,51	3,21	3,79	2,70	22
PBA439(x/xx)-QB30	305x305	30	1,70	1,51	3,21	16,79	5,40	50
PBA439(x/xx)-QB60	305x305	60	1,70	1,51	3,21	36,79	10,80	100
PBA439(x/xx)-BB30	300x400	30	2,08	1,86	3,94	16,06	5,40	50
PBA439(x/xx)-BB60	300x400	60	2,08	1,86	3,94	36,06	10,80	100
PBA439(x/xx)-B30	400x500	30	3,45	2,85	6,30	13,70	5,40	50
PBA439(x/xx)-B60	400x500	60	3,45	2,85	6,30	33,70	10,80	100
PBA439(x/xx)-B150	400x500	150	3,45	2,85	6,30	43,70	27,00	200
PBA439(x/xx)-BC60	500x650	60	7,00	5,80	12,80	27,20	10,80	100
PBA439(x/xx)-BC150	500x650	150	7,00	5,80	12,80	65,00	27,00	250
PBA439(x/xx)-BC300	500x650	300	7,00	5,80	12,80	187,20	54,00	500
PBA439(x/xx)-CC60	600x800	60	9,36	11,00	20,36	19,64	10,80	100
PBA439(x/xx)-CC150	600x800	150	9,36	11,00	20,36	79,64	27,00	250
PBA439(x/xx)-CC300	600x800	300	9,36	11,00	20,36	179,64	54,00	500
PBA439(x/xx)-CC600	600x800	600	11,50	14,10	25,60	124,40	108,00	750

## 6.5.2 Tabella del precarico in libbre

Tipo	Dimensioni [pollici]	Carico max. (3)	Precarico sezione sup. (4)	Precarico piatto di pesatura (5)	Precarico da fabbrica (6)	Riserva di precarico mecc. (7)	Intervallo di azzeramento (8)	Intervallo di carico max. (1)
PBA439(x/xx)-QA6	9x9	10	2,29	2,09	4,39	9,86	1,8	24
PBA439(x/xx)-A6	9,5x11,8	10	3,28	2,71	6,00	8,25	1,8	24
PBA439(x/xx)-A15	9,5x11,8	25	3,28	2,71	6,00	17,51	4,5	49
PBA439(x/xx)-QB15	12x12	25	3,75	3,33	7,08	16,42	4,5	49
PBA439(x/xx)-QB30	12x12	50	3,75	3,33	7,08	53,15	9,0	110
PBA439(x/xx)-QB60	12x12	100	3,75	3,33	7,08	113,39	18,0	220
PBA439(x/xx)-BB30	11,8x15,7	50	4,59	4,10	8,69	51,54	9,0	110
PBA439(x/xx)-BB60	11,8x15,7	100	4,59	4,10	8,69	111,78	18,0	220
PBA439(x/xx)-B30	15,7x19,7	50	7,61	6,28	13,89	46,34	9,0	110
PBA439(x/xx)-B60	15,7x19,7	100	7,61	6,28	13,89	106,57	18,0	220
PBA439(x/xx)-B150	15,7x19,7	250	7,61	6,28	13,89	177,04	45,0	441
PBA439(x/xx)-BC60	19,7x25,6	100	15,43	12,79	28,22	92,24	18,0	220
PBA439(x/xx)-BC150	19,7x25,6	250	15,43	12,79	28,22	157,86	45,0	551
PBA439(x/xx)-BC300	19,7x25,6	500	15,43	12,79	28,22	574,09	90,0	1102
PBA439(x/xx)-CC60	23,6x29,5	100	20,64	24,25	44,89	75,58	18,0	220
PBA439(x/xx)-CC150	23,6x29,5	250	20,64	24,25	44,89	256,27	45,0	551
PBA439(x/xx)-CC300	23,6x29,5	500	20,64	24,25	44,89	557,43	90,0	1102
PBA439(x/xx)-CC600	23,6x29,5	1000	25,35	31,09	56,44	597,03	180,0	1653

## 6.6 Accessori

### Colonna

N. articolo	Designazione	Descrizione
72229393	Colonna aperta 120 mm / 4,7"	Adatta per tutte le misure della piattaforma
72198702	Colonna aperta 330 mm / 13"	Adatta per tutte le misure della piattaforma
72198703	Colonna aperta 660 mm / 26"	Adatta per tutte le misure della piattaforma
72198704	Colonna aperta 900 mm / 35,4"	Adatta per tutte le misure della piattaforma più grandi della misura A

### Carrello in acciaio inossidabile

N. articolo	Designazione	Descrizione
72225939	Carrello in acciaio inossidabile BC	Adatto per la piattaforma di misura BC
72225940	Carrello in acciaio inossidabile CC	Adatto per la piattaforma di misura CC

### Pista a rulli

N. articolo	Designazione	Descrizione
30253326	Pista a rulli 400 × 500 mm / 15,7" × 19,7" acciaio inossidabile	Adatto per la piattaforma di misura B. Verso il lato corto della piattaforma
30253328	Pista a rulli 500 × 650 mm / 19,7" × 25,6" acciaio inossidabile	Adatta per la piattaforma di misura BC. Verso il lato corto della piattaforma
30253330	Pista a rulli 600 × 800 mm / 23,6" × 31,5" acciaio inossidabile	Adatta per la piattaforma di misura CC. Verso il lato corto della piattaforma
30253327	Pista a rulli 400 × 500 mm / 15,7" × 19,7" acciaio inossidabile	Adatto per la piattaforma di misura B. Verso il lato lungo della piattaforma
30253329	Pista a rulli 500 × 650 mm / 19,7" × 25,6" acciaio inossidabile	Adatta per la piattaforma di misura BC. Verso il lato lungo della piattaforma
30253331	Pista a rulli 600 × 800 mm / 23,6" × 31,5" acciaio inossidabile	Adatta per la piattaforma di misura CC. Verso il lato lungo della piattaforma
30640393	Pista a rulli 400 × 500 mm / 15,7" × 19,7" acciaio inossidabile	Adatta per aree pericolose
30640394	Pista a rulli 500 × 650 mm / 19,7" × 25,6" acciaio inossidabile	Adatta per aree pericolose
30640395	Pista a rulli 600 × 800 mm / 23,6" × 31,5" acciaio inossidabile	Adatta per aree pericolose

### Staffa di montaggio anteriore

N. articolo	Designazione	Descrizione
22021062	Staffa di montaggio anteriore	Adatta per montaggio anteriore ICS4_9

### Piatto in acciaio inossidabile

N. articolo	Designazione	Descrizione
30676769	Piatto in acciaio inossidabile AISI 316 240 x 300 mm / 9,5" x 11,8"	Adatto per la piattaforma di misura A
30676770	Piatto in acciaio inossidabile AISI 316 300 x 400 mm / 11,8" x 15,7"	Adatto per la piattaforma di misura BB
30676771	Piatto in acciaio inossidabile AISI 316 400 x 500 mm / 15,7" x 19,7"	Adatto per la piattaforma di misura B
30676772	Piatto in acciaio inossidabile AISI 316 228 x 228 mm / 9" x 9"	Adatto per la piattaforma di misura QA
30676773	Piatto in acciaio inossidabile AISI 316 305 x 305 mm / 12" x 12"	Adatto per la piattaforma di misura QB
30676774	Piatto in acciaio inossidabile AISI 316 500 x 650 mm / 19,7" x 25,6"	Adatto per la piattaforma di misura BC

N. articolo	Designazione	Descrizione
30676775	Piatto in acciaio inossidabile AISI 316, spessore 2,0 mm, 600 x 800 mm / 23,6" x 31,5"	Adatto per la piattaforma di misura CC
30676776	Piatto in acciaio inossidabile AISI 316, spessore 2,5 mm, 600 x 800 mm / 23,6" x 31,5"	Adatto per la piattaforma di misura CC

## 7 Possibilità di montaggio

Il PBA439(x/xx) supporta il montaggio su un dispositivo stabile. Se è necessario forare la piattaforma di pesatura, attenersi allo schema dei fori sottostante.



**NOTA: le aree tratteggiate si trovano dove è consentito forare la piattaforma di pesatura.**

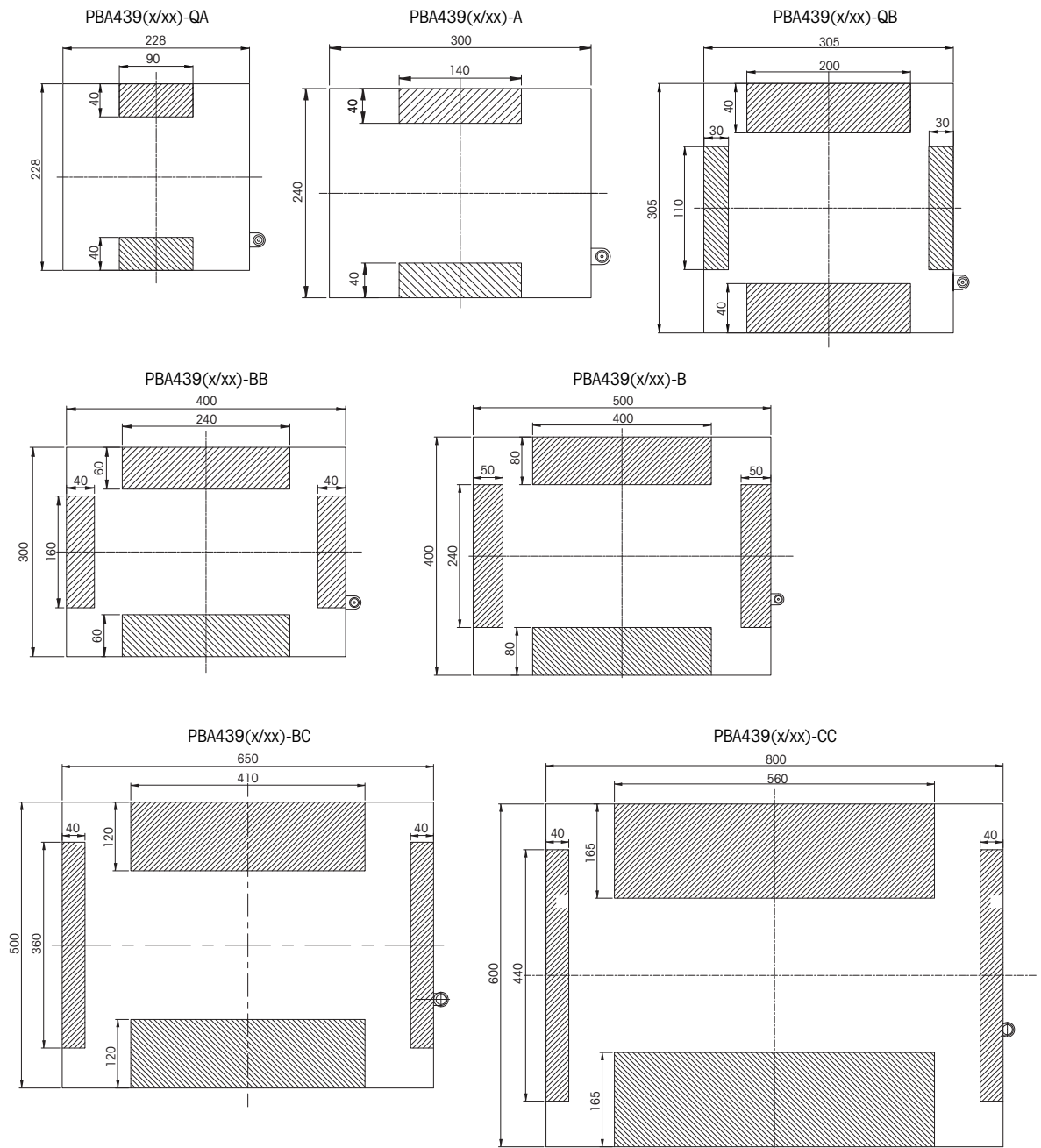

Misure in [mm]



## 8 Appendice

### 8.1 Etichetta

<p>IS CL I,II,III DIV 1, GP ABCDEFG T6...T4          Class I, Zone 1, AEx ia IIC T6...T4 Gb          Class II,III, Zone21, AEx ia IIIC T80°C Db          -40°C&lt;Ta&lt;60°C T5/T4; -40°C&lt;Ta&lt;40°C T6          FM21US0076X</p>			<p>II 2G Ex ia IIC T6...T4 Gb          II 2D Ex ia IIIC T80°C Db          -40°C&lt;Ta&lt;60°C T5/T4          -40°C&lt;Ta&lt;40°C T6</p>
<p>IS CL I,II,III DIV 1, GP ABCDEFG T6...T4          Class I, Zone 1, Ex ia IIC T6...T4 Gb          Class II,III, Zone21, Ex ia IIIC T80°C Db          -40°C&lt;Ta&lt;60°C T5/T4; -40°C&lt;Ta&lt;40°C T6          FM21CA0051X</p>		<p>Entity/NIFW for Nonincendive Field Wiring. Entity parameters are shown in drawing 30688074          Mettler-Toledo GmbH, Im Langacher 44, 8606 Greifensee, Switzerland</p>	

<p>NI CL I,II,III DIV 2 GP ABCDFG T6          -40°C&lt;Ta&lt;60°C          FM21US0076X</p>			<p>II 3G Ex ic IIC T6...T4 Gc          -40°C&lt;Ta&lt;60°C T5/T4          -40°C&lt;Ta&lt;40°C T6</p>
<p>NI CL I,II,III DIV 2 GP ABCDEFG T6...T4          -40°C&lt;Ta&lt;60°C          Class I, Zone 2, Ex ec IIC T6 Gc;          Class II,III, Zone22, Ex tc IIIC T80°C Dc          FM21CA0051X</p>		<p>II 3G Ex ec IIC T6 Gc U-rated=20V          II 3D Ex tc IIIC T80°C Dc I-rated=50mA          -40°C&lt;Ta&lt;60°C</p>	
		<p>Entity/NIFW for Nonincendive Field Wiring. Entity parameters are shown in drawing 30688074          Mettler-Toledo GmbH, Im Langacher 44, 8606 Greifensee, Switzerland</p>	





## 8.2 Schema di controllo

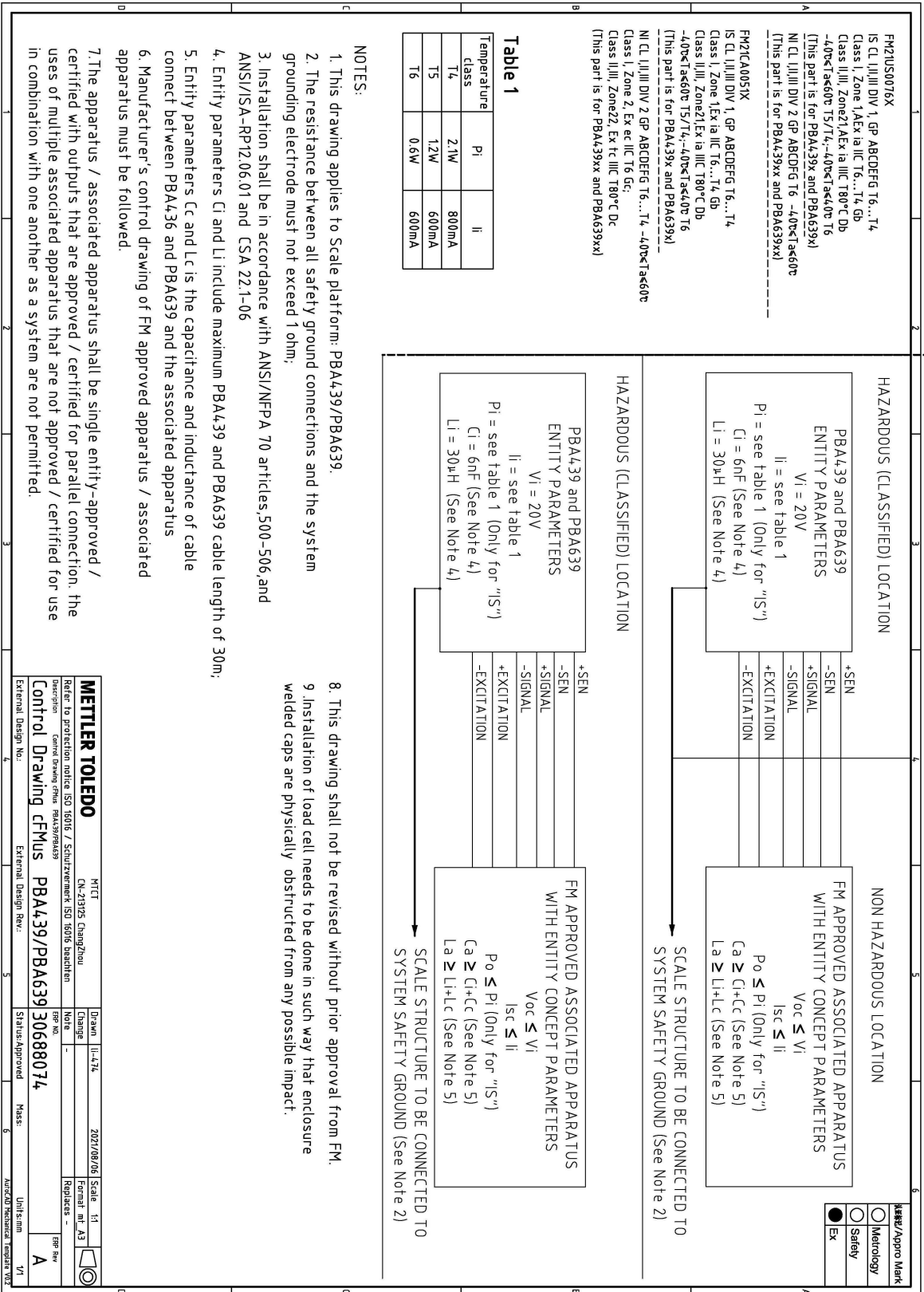

<b>METTLER TOLEDO</b>		MTC	Scale: 1:1
Refer to protection notice ISO 10316 / Schutzvermerk ISO 10316 beachten		DN-23125 Changzhou	2021/08/06
Control Drawing CFMUS		PBA439/PBA639	30688074
External Design No.:		External Design Rev.:	Status: Approved
External Design No.:		External Design Rev.:	Phase:
External Design No.:		External Design Rev.:	Unit/Item
External Design No.:		External Design Rev.:	Aut/20/2020/06/10/2020/06/10/2020/06/10

### 8.3 Disegno di installazione

#### Hazardous (Classified) Location

IP67 II 3G Ex ic IIC T6...T4 Gc  
-40°C≤Tas60°C T5/T4; -40°C≤Tas40°C T6

II 3G Ex ec IIC T6 Gc -40°C≤Tas60°C T6  
II 3D Ex tc IIIC T80°C Dc  
FM21UKEX0080X  
FM21ATEX0025X IECEX FMG21.0003X

---

II 2G Ex ia IIC T6...T4 Gb  
-40°C≤Tas60°C T5/T4; -40°C≤Tas40°C T6

II 2D Ex ia IIIC T80°C Db  
FM21UKEX0079X  
FM21ATEX0003X IECEX FMG21.0003X

Approval Mark

THIS ITEM IS PART OF AGENCY APPROVED PRODUCT

Metrology  
 Safety  
 Ex

DO NOT CHANGE DOCUMENT WITHOUT APPROPRIATE APPROVAL

SLP84x Load Cell

U<sub>i</sub> = 20V  
l<sub>i</sub> = see table2  
P<sub>i</sub> = see table 2  
C<sub>i</sub> = 6nF  
L<sub>i</sub> = 30uH

+Excitation(Green)

-Excitation(Black)

+SEN(Yellow)

-SEN(Blue)

+Signal(White)

-Signal(Red)

Ex Approved Associated Apparatus with Entity Concept Parameters

U<sub>o</sub> ≤ U<sub>i</sub>  
I<sub>o</sub> ≤ I<sub>i</sub>  
P<sub>o</sub> ≤ P<sub>i</sub>  
C<sub>o</sub> ≥ C<sub>c</sub>+C<sub>i</sub>  
L<sub>o</sub> ≥ L<sub>c</sub>+L<sub>i</sub>

Scale structure (attached to load cell) to be connected to system safety ground. See Note.

**NOTES:**

- 1.The resistance between all safety ground connections and the system grounding electrode must not exceed 1ohm.
- 2.Installation shall be in accordance with relevant electrical installation standards (Being shown in Table 1)in hazardous areas(other than mines).
- 3.Entity Parameters C<sub>i</sub> And L<sub>i</sub> Include Maximum Load Cell Cable Length Of 30m
- 4.Entity Parameters C<sub>c</sub> and L<sub>c</sub> is the capacitance and inductance of cable connect between load cell and the associated apparatus.
- 5.In an explosive atmosphere caused by air/dust mistures, the loose ends of the cable shall be connected outside the hazardous area or in a suitable enclosure with a degree of protection of at least IP6X in accordance with EN 60529.
- 6.For the application of Ex ec, Ex tc: U<sub>rated</sub>=20V,I<sub>rated</sub>=50mA.
- 7.Installation of load cell needs to be done in such way that enclosure welded caps are physically obstructed from any possible impact.
8. ⚠ Not following these instructions will jeopardize the explosion safety.
9. For the application of Ex ec, The equipment shall only be used in an area of at least pollution degree 2, as defined in IEC 60664-1.

Table 1

EN60079-0: 2018	EN60079-14: 2014	EN60079-11: 2012	EN60079-31: 2014
EN61241-14: 2004	EN60079-31: 2013	EN60079-7: 2015	IEC60079-31: 2013
IEC 60079-0-2017	IEC 60079-11-2011	IEC 60079-14-2013	IEC60079-7: 2015

Table 2

Temperature class	P <sub>i</sub>	l <sub>i</sub>
T4	2.1W	800mA
T5	1.2W	600mA
T6	0.6W	600mA

Mettler-Toledo GmbH, Im Langacher 44, 8606 Greifensee, Switzerland  
Mettler-Toledo Ltd. 64 Boston Rd.Leicester, LE4 1AW, United Kingdom

D	update drawing status	Wang Jianwen	Liu yuchun		2021-7-26
C	removed Ex nA of note6	Wang Jianwen	Liu yuchun		2021-1-15
REV / CHG	DESCRIPTION	BY	APPVD	AGENCY	E.R. No. DATE
RECORD OF CHANGES					
<b>METTLER TOLEDO</b>		Drawn	Wang JW	2020/05/11	Scale 1:1
MTCZ CN-213022 ChangZhou		Change			Format mt_A4
Refer to protection notice ISO 16016 / Schutzvermerk ISO 16016 beachten		Note	-		Replaces -
Description 防爆安装图 SLP84X		ERP NO.	30555321		ERP Rev
<b>INSTALLATION DRAWING SLP84X ATEX/IECEX</b>		<b>30555321</b>		<b>D</b>	
External Design No.:D000644580		External Design Rev.:D		Status:Approved	Mass: Units:mm 1/1

AutoCAD Mechanical Template V0.2

# METTLER TOLEDO Service

Hartelijk gefeliciteerd dat u hebt gekozen voor de kwaliteit en precisie van METTLER TOLEDO. Zorgvuldig gebruik van uw nieuwe apparatuur conform deze handleiding en regelmatige kalibratie en onderhoud door onze professionele klantenservice verzekeren een langdurig betrouwbare werking en waardebehoud van uw meetapparatuur. Neem contact met ons op voor een service-overeenkomst afgestemd op uw behoeften en budget. Zie voor meer informatie ► [www.mt.com/service](http://www.mt.com/service).

Er zijn een aantal manieren om het meeste te halen uit uw investering:

- 1 **Registreer uw product:** Registreer uw nieuwe product onder [www.mt.com/productregistration](http://www.mt.com/productregistration) zodat wij u kunnen informeren over verbeteringen, updates en andere belangrijke mededelingen betreffende uw product.
- 2 **Neem contact op met METTLER TOLEDO voor service:** De waarde van een meting is evenredig aan de nauwkeurigheid ervan – een weegschaal die weegt buiten zijn specificaties kan kwaliteit en winstgevendheid verminderen en aansprakelijkheidsrisico's vergroten. Tijdige service door METTLER TOLEDO garandeert de nauwkeurigheid en optimaliseert de beschikbaarheid en levensduur van de apparatuur.
  - ➔ **Installatie, configuratie, integratie en training:** Onze servicemonteurs zijn professioneel getrainde experts op het gebied van weegapparatuur. Wij zorgen ervoor dat uw weegapparatuur gebruiksklaar is, vlot en tegen lage kosten, en dat uw personeel succesvol is geïnstrueerd.
  - ➔ **Initiële kalibratiedocumentatie:** De installatie-omgeving en randvoorwaarden van de toepassing zijn uniek voor elke industriële weegschaal, daarom moeten de prestaties worden getest en gecertificeerd. Onze kalibratiediensten en -certificaten documenteren de nauwkeurigheid voor een juiste productiekwaliteit in het kader van een kwaliteitssysteem.
  - ➔ **Periodieke kalibratie:** Een kalibratieservice-overeenkomst verschaft blijvende zekerheid dat uw weegproces en documentatie in overeenstemming zijn met de eisen. Wij bieden diverse serviceschema's, afgestemd op uw behoeften en budget.



# Inhoudsopgave

<b>1</b>	<b>Veiligheidsinstructies</b>	<b>3</b>
1.1	Bedoeld gebruik.....	3
1.2	Niet-bedoeld gebruik.....	3
1.3	Veiligheidsmaatregelen.....	3
1.4	Specifieke gebruiksvoorwaarden.....	3
<b>2</b>	<b>Inleiding</b>	<b>4</b>
2.1	Assortiment.....	4
2.2	Over deze handleiding.....	4
2.3	Overige documenten.....	4
<b>3</b>	<b>Installatie en bediening</b>	<b>5</b>
3.1	Aansluiten van het weegplatform op de weegterminal.....	5
3.2	Waterpas afstellen.....	6
3.3	Potentiaalvereffening.....	6
3.4	Controleren van het weegplatform.....	6
3.5	Gebruik van het weegplatform.....	7
3.6	Installatie, configuratie, service en reparatie.....	7
<b>4</b>	<b>Onderhoud</b>	<b>8</b>
4.1	Aanwijzingen voor reiniging.....	8
4.2	Vervolgbehandeling.....	8
4.3	Veiligheidsopmerking.....	9
<b>5</b>	<b>Reparatie</b>	<b>10</b>
<b>6</b>	<b>Technische gegevens en gebruiksgrenzen</b>	<b>11</b>
6.1	Maximale ijkwaarde.....	11
6.2	Maximale toegestane belasting.....	11
6.3	Technische gegevens weegcel.....	12
6.3.1	Ex-goedkeuring.....	12
6.3.2	Nalevingsnorm weegcel.....	12
6.4	Afmetingen.....	14
6.5	Informatie over voorbelasting.....	15
6.5.1	Voorbelastingtabel in kilogram.....	16
6.5.2	Voorbelastingtabel in ponden.....	17
6.6	Accessoires.....	18
<b>7</b>	<b>Montagemogelijkheden</b>	<b>20</b>
<b>8</b>	<b>Bijlage</b>	<b>21</b>
8.1	Etiket.....	21
8.2	Besturingsschema.....	22
8.3	Installatietekening.....	23



# 1 Veiligheidsinstructies

## 1.1 Bedoeld gebruik

PBA439(x/xx) weegplatformen maken deel uit van een modulair weegstelsel bestaande uit een METTLER TOLEDO weegterminal als display en ten minste één weegplatform.

- Gebruik het weegplatform uitsluitend voor weegwerkzaamheden in overeenstemming met deze handleiding.
- Het weegplatform is uitsluitend bedoeld voor gebruik binnenshuis.
- Uitsluitend PBA439x/xxweegplatformen zijn geschikt voor gebruik in explosiegevaarlijke omgevingen conform onderstaande specificaties.
- Elk ander gebruik wordt beschouwd als niet-bedoeld gebruik.

### Wettelijke metrologie

- Gebruik uitsluitend goedgekeurde weegplatformen voor gebruik dat valt onder wettelijke metrologie.
- Bij gebruik voor wettelijke metrologie is de gebruiker verantwoordelijk voor naleving van alle nationale weeg- en meetvoorschriften.
- Neem contact op met de METTLER TOLEDO serviceorganisatie bij vragen over het gebruik voor wettelijke handelstoepassingen.

## 1.2 Niet-bedoeld gebruik

- Gebruik de weegterminal niet voor andere werkzaamheden dan wegen.
- Gebruik het weegplatform niet in een andere omgeving dan vermeld in --- MISSING LINK ---.
- Breng geen wijzigingen aan aan het weegplatform.
- Gebruik de weegterminal niet buiten de grenzen van de technische specificaties.
- Gebruik het weegplatform niet als opslagruimte.
- Voorkom het vallen van voorwerpen op het weegplatform.

## 1.3 Veiligheidsmaatregelen

- Uitsluitend personeel dat is opgeleid en gekwalificeerd door METTLER TOLEDO mag het weegplatform installeren en onderhouden.
- Wees voorzichtig bij het verplaatsen en hijsen van zwaar materieel.
- Koppel het weegplatform altijd los van de voeding voor uitvoering van installatie-, service-, reinigings- en onderhoudswerkzaamheden.
- De aansluitkabel mag niet worden losgekoppeld van de weegterminal terwijl deze ingeschakeld is.
- Controleer dat het weegplatform op kamertemperatuur is voordat de voeding wordt ingeschakeld.
- De explosieveilige weegplatformen PBA439x/xx zijn goedgekeurd voor gebruik in de volgende explosiegevaarlijke gebieden:
  - ATEX-/IECEx-categorie 2, -categorie 3, gas/stof (Ex-zone 1/21, Ex-zone 1/21)
  - cFMus, Class I, II, III, Division 1, Division 2
- Wanneer weegplatformen worden gebruikt in explosiegevaarlijke gebieden bestaat er een verhoogd risico op letsel en materiële schade! Bij gebruik in dergelijke gebieden moeten speciale voorzorgsmaatregelen worden getroffen.
- Gebruik voor PBA439x/xx weegplatformen uitsluitend kabelwartels die geschikt en goedgekeurd zijn voor explosiegevaarlijke gebieden om de weegcelkabel in de weegterminal in te voeren.
- Explosieveilige weegplatformen mogen uitsluitend worden gebruikt in explosiegevaarlijke gebieden in combinatie met weegterminals met de juiste goedkeuring en interfacespecificaties.

## 1.4 Specifieke gebruiksvoorwaarden

- In een explosieve atmosfeer veroorzaakt door een lucht/stof-mengsel moeten de losse uiteinden van de kabel buiten het explosiegevaarlijke gebied worden aangesloten of in een passende behuizing met een beschermingsgraad van ten minste IP6X conform EN-IEC 60529.

## 2 Inleiding

### 2.1 Assortiment

Deze handleiding betreft de productserie PBA439(x/xx).

De PBA439(x/xx)-serie bestaat uit diverse weegplatformen die voldoen aan uw specifieke behoeften. De serie is ijkbaar en is beschikbaar in diverse afmetingen en capaciteiten

Type	Materiaal weeg-plateau	Materiaal weeg-schaalframe	Uitvoering weegcel	Beschermingsgraad	Ex-goedkeuring
PBA439	Roestvrij staal AISI304	Roestvrij staal AISI304	Roestvrij staal, hermetisch afge- dicht	Droog, nat, IP68/IP69K	-
PBA439x					Zone 1/21, Division 1
PBA439xx					Zone 2/22, Division 2

### 2.2 Over deze handleiding



Deze handleiding bevat alle informatie voor bedieners van het product.

- Lees deze handleiding zorgvuldig door voor gebruik.
- Bewaar deze handleiding voor toekomstig gebruik.
- Geef deze handleiding door aan een toekomstige eigenaar of gebruiker van het product.

### 2.3 Overige documenten

Naast deze handleiding kunt u onderstaande documenten downloaden van ► [www.mt.com](http://www.mt.com):

- Brochure
- Installatie-informatie (voor ervaren personeel onder regie van de gebruiker)
- Typegoedkeuringsdocumenten

#### Certificaten

Certificaten voor de US, Canada, ATEX, UKEX en IECEx kunnen worden gedownload van ► <https://www.mt.com/us/en/home/search/compliance.html/compliance/>.



## 3 Installatie en bediening

### 3.1 Aansluiten van het weegplatform op de weegterminal

Het PBA439(x/xx) weegplatform is bedoeld voor gebruik met analoge METTLER TOLEDO weegterminals.

- 1 Voer de kabel van het weegplatform via de kabelwartel in in de weegterminal.
- 2 Sluit de kabel van het weegplatform aan op de klemmenstrook van de weegterminal overeenkomstig onderstaande tabel.

Signaal	Aderkleur	Connector
SIG+	wit	
SIG-	rood	
EXC+	groen	
EXC-	zwart	
SEN+	geel	
SEN-	blauw	



#### **WAARSCHUWING**

De kabelmantel moet worden geaard.

#### Veiligheidsmaatregelen voor aansluitingen

- Neem bij het aansluiten van het weegplatform in explosiegevaarlijk gebied nauwkeurig het besturingschema in acht in de [Bijlage ► pagina 21].
- Verifieer dat is voldaan aan de speciale voorwaarden voor een veilig gebruik zoals vermeld op de schema's en certificaten in de [Bijlage ► pagina 21].
- De kabelmantel moet worden aangesloten op het veerelement (behuizing) van de weegcel. Zorg voor een juiste verbinding tussen weegcel en terminal (of aansluitdoos) conform het installatiescenario.
- De weerstand tussen alle aansluitingen van de veiligheidsaarde en de aardelektrode mag niet meer bedragen dan 1 ohm.
- De installatie moet worden uitgevoerd in overeenstemming met relevante elektrische normen.
- Het niet opvolgen van deze instructies kan leiden tot explosiegevaar.

### 3.2 Waterpas afstellen

Uitsluitend een nauwkeurig waterpas afgesteld weegplatform geeft nauwkeurige weegresultaten. Het weegplatform moet waterpas worden afgesteld bij de eerste installatie en elke keer dat het wordt verplaatst.

- 1 Verdraai de stelpoten van het weegplatform tot de luchtbel van de waterpas zich in de binnenste cirkel bevindt.
- 2 Draai de borgmoeren van de stelpoten vast.

👉 Scan de QR-code om de video te bekijken

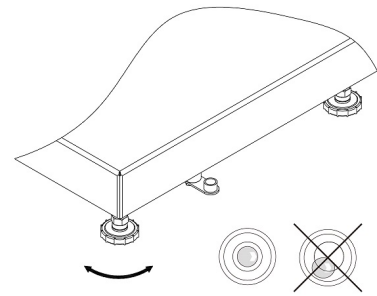

### 3.3 Potentiaalvereffening

PBA439x/xx weegplatformen zijn af fabriek voorzien van potentiaalvereffening. Bij de klant moet de bekabeling worden aangesloten door een gekwalificeerd elektricien. De METTLER TOLEDO service heeft hierbij slechts een toezienende en adviserende functie. Sluit de potentiaalvereffening (PA) van alle apparaten (weegplatform en weegterminal) aan in overeenstemming met de nationale voorschriften en normen. Controleer daarbij dat de behuizingen van alle apparaten met hun PA-aansluiting zijn aangesloten op dezelfde potentiaal.

#### Opmerking

De apparatuur is beschermd tegen elektrische schokken conform IEC 60950, klasse II.

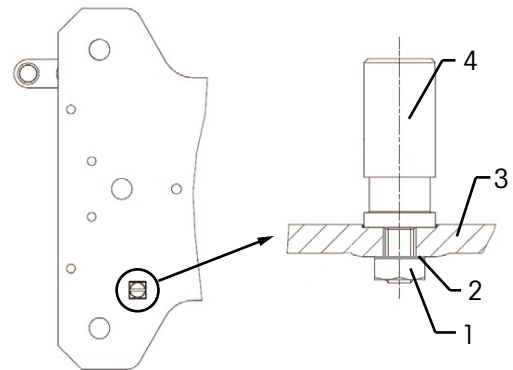

- 1 - Zeskantborgmoer, M4 KEPS
  - 2 - Sluistring
  - 3 - Frame
  - 4 - Aansluiting potentiaalvereffening, aanhaalmoment 3.5 Nm
- Bestelnummer van de potentiaalvereffeningskit 72237321

### 3.4 Controleren van het weegplatform

#### Functionele controle

- 1 Controleer dat het weegplatform is aangesloten op een weegterminal en dat de weegterminal is ingeschakeld.
- 2 Controleer dat het weegplatform onbelast is en het display van de weegterminal op 0 staat.
- 3 Belaad het weegplatform. De weegterminal moet een waarde ongelijk 0 weergeven.
- 4 Maak het weegplatform leeg. De weegterminal moet weer op 0 staan.

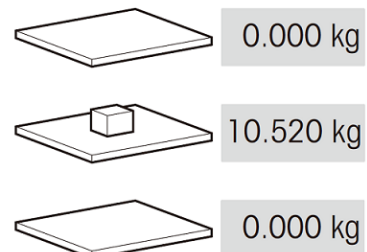

#### Keuringcontrolle

Zie voor een keuringcontrolle de bedieningshandleiding van de aangesloten weegterminal. Wanneer de verzegeling is verbroken, is de keuring niet langer geldig.

### 3.5 Gebruik van het weegplatform

Neem het onderstaande in acht voor optimale weegresultaten:

- Zorg ervoor dat de laadplaat correct is geplaatst.

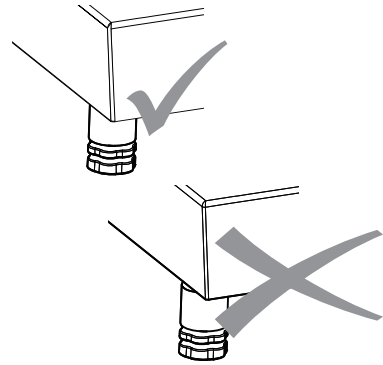

- Plaats voor optimale resultaten het weegproduct altijd op dezelfde positie op het weegplatform.

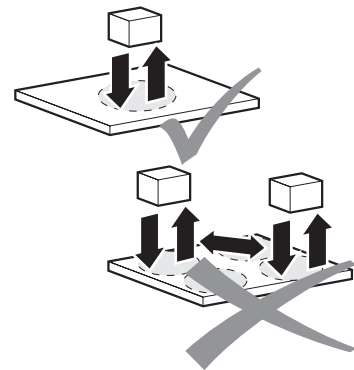

- Voorkom krassen en slijtage.

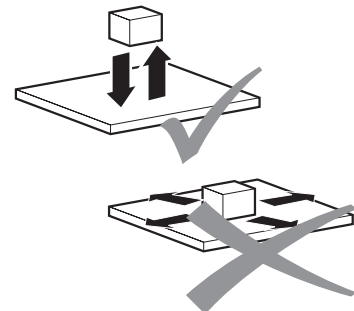

- Voorkom belasting door vallende voorwerpen, schokken en zijdelingse stoten.

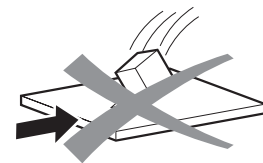

### 3.6 Installatie, configuratie, service en reparatie

Neem voor installatie, configuratie, service en reparatie van weegplatformen contact op met de METTLER TOLEDO service.

## 4 Onderhoud

### 4.1 Aanwijzingen voor reiniging

---

#### Opmerking

##### Schade aan het weegplatform door onjuist gebruik van reinigingsmiddelen.

- Gebruik desinfectie- en reinigingsmiddelen uitsluitend in overeenstemming met de instructies van de fabrikant.
- Gebruik geen sterke zuren en basen en geen reinigingsmiddelen met een hoge chloorconcentratie. Vermijd stoffen met een hoge of lage pH-waarde, omdat deze verhoogd aanleiding kunnen geven tot corrosie.
- Wees in het bijzonder voorzichtig bij het reinigen van de weegcel.

---

#### Reinigingsprocedure

- Verwijder regelmatig vuil en aangekoekte resten van de buiten- en binnenzijde van het weegplatform.
  - ➔ De te volgen procedure is afhankelijk van het type oppervlak en de heersende omgevingsomstandigheden op de installatielocatie.

##### Reiniging in een vochtige omgeving (roestvrij stalen uitvoering)

- Gebruik een waterstraal tot 80 °C / 176 °F en max. 80 bar op een afstand van ten minste 40 cm / 16".
- Gebruik huishoudelijke reinigingsmiddelen.

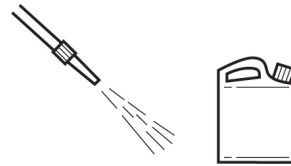

##### Reiniging in een corrosieve omgeving (roestvrij stalen uitvoering)

- Gebruik een waterstraal.
  - Inwendige reiniging**, weegcel, weegplateau geopend: tot 60 °C / 140 °F en max. 2 bar, afstand ten minste 40 cm / 16".
  - Uitwendige reiniging**, weegplateau gesloten: tot 80 °C / 176 °F en max. 80 bar, afstand ten minste 40 cm / 16".
- Verwijder regelmatig corrosieve stoffen.
- Gebruik desinfectie- en reinigingsmiddelen uitsluitend in overeenstemming met de specificaties en instructies van de fabrikant

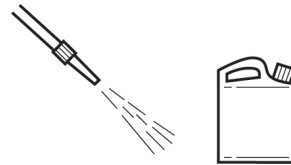

### 4.2 Vervolgbehandeling

Voer onderstaande vervolgbehandeling uit ter bescherming van de weegschaal:

- Spoel de weegschaal af met schoon water en verwijder alle resten van het reinigingsmiddel.
- Droog de weegschaal af met een pluisvrije doek.
- Behandel de binnen- en buitenzijde van roestvrij stalen weegschalen met een olie die geschikt is voor levensmiddelen.

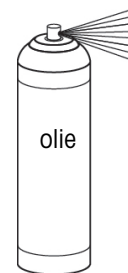

### 4.3 Veiligheidsopmerking

Volgens de Europese richtlijn 2012/19/EU betreffende afgedankte elektrische en elektronische apparatuur (AEEA) mag dit apparaat niet worden afgevoerd als huishoudelijk afval. Dit geldt ook voor landen buiten de EU, op basis van de daar geldende specifieke vereisten.

Voer dit product overeenkomstig de plaatselijke voorschriften af naar het verzamelpunt dat is aangewezen voor elektrische en elektronische apparatuur. In geval van vragen kunt u contact opnemen met de verantwoordelijke autoriteiten of de leverancier waar u dit apparaat hebt gekocht. Als dit apparaat aan derden wordt doorgegeven, moet ook de inhoud van deze verordening worden doorgegeven.



## **5 Reparatie**

Deze apparatuur is gecertificeerd voor gebruik in explosiegevaarlijke gebieden, daarom zijn aanpassingen niet toegestaan. Reparaties mogen uitsluitend worden uitgevoerd door personeel dat is opgeleid voor reparatie van dergelijke apparatuur.

## 6 Technische gegevens en gebruiksgrenzen

### 6.1 Maximale ijkwaarde

Max. ijkwaarde [e] / OIML	Capaciteit							
	3 kg	6 kg	15 kg	30 kg	60 kg	150 kg	300 kg	600 kg
1 x 3000e Max / e [kg]	3 / 0.001	6 / 0.002	15 / 0.005	30 / 0.01	60 / 0.02	150 / 0.05	300 / 0.1	600 / 0.2

Max. ijkwaarde [d] / NTEP	Capaciteit							
	-	10 lb	25 lb	50 lb	100 lb	250 lb	500 lb	1000 lb
1 x 5000d Max / d [lb]	-	10 / 0.002	25 / 0.005	50 / 0.01	100 / 0.02	250 / 0.05	500 / 0.1	1000 / 0.2

### 6.2 Maximale toegestane belasting

Alle weegplatformen zijn voorzien van een beveiliging tegen overbelasting. Door de robuuste uitvoering van de weegschaal leidt een enkele overschrijding van de nominale capaciteit van het platform niet tot schade. De maximaal toegestane statische belasting mag nooit worden overschreden.

- Neem onderstaande gebruiksgrenzen in acht.

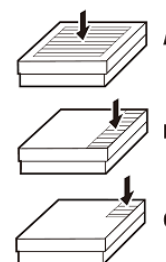

Model	A - centrale belasting	B - randbelasting	C - hoekbelasting
PBA439(x/xx)-QA	40 kg / 80 lb	30 kg / 60 lb	15 kg / 30 lb
PBA439(x/xx)-A	40 kg / 80 lb	30 kg / 60 lb	15 kg / 30 lb
PBA439(x/xx)-QB	100 kg / 200 lb	70 kg / 140 lb	35 kg / 70 lb
PBA439(x/xx)-BB	100 kg / 200 lb	70 kg / 140 lb	35 kg / 70 lb
PBA439(x/xx)-B	200 kg / 400 lb	140 kg / 280 lb	75 kg / 150 lb
PBA439(x/xx)-BC	400 kg / 800 lb	300 kg / 600 lb	150 kg / 300 lb
PBA439(x/xx)-CC	700 kg / 1400 lb	400 kg / 800 lb	200 kg / 400 lb



#### **WAARSCHUWING**

**Voorkom val-, schokbelastingen en stoten tegen de zijkanten.**

### 6.3 Technische gegevens weegcel

Nominale output	mV/V	1,8 ± 0.2
Ingangsweerstand	Ω	384 ± 15
Uitgangsweerstand	Ω	350 ± 4
Aanbevolen spanning	V (DC / AC)	5 - 15
Max. excitatiespanning	V (DC / AC)	20
Kabelmantel	-	PVC
IP-graad	-	IP68/IP69K

#### 6.3.1 Ex-goedkeuring

Deze paragraaf betreft uitsluitend de Ex-relevante aspecten van het product.

De weegcel SLP84x (x = 6, 7, 8) is voorzien van:

ATEX-certificaat	FM21ATEX0003X, FM21ATEX0025X
UK-certificaat	FM21UKEX0079X, FM21UKEX0080X
IECEX-certificaat	IECEX FMG21.0003X
US-certificaat	FM21US0005X
Canada-certificaat	FM21CA0002X

Zie voor bovenstaande certificaten en de betreffende installatieschema's de [Bijlage ► pagina 21].

#### 6.3.2 Nalevingsnorm weegcel

##### US-normen

Titel	Nummer	Uitgiftedatum
Elektrisch materieel voor gebruik in explosiegevaarlijke gebieden – Algemene eisen	FM Class 3600	2018
Intrinsiek veilig materieel en aanverwant materieel voor gebruik in als Class I, II en III, Division 1 geclassificeerde gebieden	FM Class 3610	2021
Niet-ontvlambare elektrisch materieel voor gebruik in als Class I en II, Division 2, en Class III, Division 1 en 2 geclassificeerde gebieden	FM Class 3611	2021
Elektrisch materieel voor meet- en regeltechniek en laboratoriumgebruik	FM Class 3810	2021
Explosieve atmosferen – Deel 0: Materieel - Algemene eisen	ANSI/UL 60079-0	2019
Explosieve atmosferen – Deel 11: Bescherming van materieel door intrinsieke veiligheid "i"	ANSI/ISA 60079-11	2014
Niet-ontvlambare elektrisch materieel voor gebruik in als Class I en II, Division 2, en Class III, Division 1 en 2 geclassificeerde gebieden	ANSI/UL 121201	2017
Veiligheidseisen voor elektrisch materieel voor meet- en regeltechniek en laboratoriumgebruik – Deel 1: Algemene eisen	ANSI/UL 61010-1	2012
Beschermingsgraden door een omhulling (IP-code)	ANSI/IEC 60529	2020

##### Canadese normen

Titel	Nummer	Uitgiftedatum
Niet-ontvlambaar elektrisch materieel voor gebruik in als Class I, Division 2 geclassificeerde gebieden	CSA C22.2 No. 213	2017
Explosieve atmosferen – Deel 0: Materieel - Algemene eisen	CAN/CSA-C22.2 No. 60079-0	2019
Explosieve atmosferen – Deel 11: Bescherming van materieel door intrinsieke veiligheid "i"	CAN/CSA-C22.2 No. 60079-11	2014
Explosieve atmosferen – Deel 7: Bescherming van materieel door verhoogde veiligheid "e"	CAN/CSA-C22.2 No. 60079-7	2018
Explosieve atmosferen – Deel 31: Bescherming van materieel tegen stofontbranding door omhulsel "t"	CAN/CSA-C22.2 No. 60079-31	2015



Titel	Nummer	Uitgiftedatum
Veiligheidseisen voor elektrisch materieel voor meet- en regeltechniek en laboratoriumgebruik – Deel 1: Algemene eisen	CSA C22.2 No. 61010-1	2012
Beschermingsgraden door een omhulling (IP-code)	CSA C22.2 No. 60529	2016

### IECEX-normen

Titel	Nummer	Uitgiftedatum
Explosieve atmosferen – Deel 0: Materieel - Algemene eisen	IEC 60079-0	2017
Explosieve atmosferen – Deel 11: Bescherming van materieel door intrinsieke veiligheid "i"	IEC 60079-11	2011
Explosieve atmosferen – Deel 7: Bescherming van materieel door verhoogde veiligheid "e"	IEC 60079-7	2017
Explosieve atmosferen – Deel 31: Bescherming van materieel tegen stofontbranding door omhulsel "t"	IEC 60079-31	2013
Beschermingsgraden door een omhulling (IP-code)	IEC 60529	2013

### ATEX-normen

Titel	Nummer	Uitgiftedatum
Explosieve atmosferen – Deel 0: Materieel - Algemene eisen	EN-IEC 60079-0	2018
Explosieve atmosferen – Deel 11: Bescherming van materieel door intrinsieke veiligheid "i"	EN 60079-11	2012
Explosieve atmosferen – Deel 7: Bescherming van materieel door verhoogde veiligheid "e"	EN 60079-7:	2015+ A1:2018
Explosieve atmosferen – Deel 31: Bescherming van materieel tegen stofontbranding door omhulsel "t"	EN 60079-31:	2014
Beschermingsgraden door een omhulling (IP-code)	EN 60529:	1991 + A1:2000 + A2:2013

### UKEX-normen

Titel	Nummer	Uitgiftedatum
Explosieve atmosferen – Deel 0: Materieel - Algemene eisen	EN-IEC 60079-0	2018
Explosieve atmosferen – Deel 11: Bescherming van materieel door intrinsieke veiligheid "i"	EN 60079-11:	2012
Explosieve atmosferen – Deel 7: Bescherming van materieel door verhoogde veiligheid "e"	EN 60079-7:	2015+ A1:2018
Explosieve atmosferen – Deel 31: Bescherming van materieel tegen stofontbranding door omhulsel "t"	EN 60079-31:	2014
Beschermingsgraden door een omhulling (IP-code)	EN 60529	1991 + A1:2000 + A2:2013

## 6.4 Afmetingen

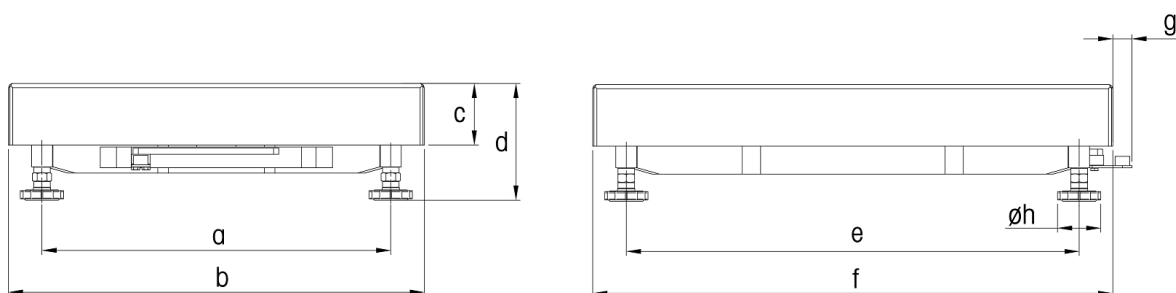

Afmetingen		a	b	c	d *	e	f	g	h
PBA439(x/xx)-QA	mm	163	228	56	85,6	163	228	21	42
	inch	6,42	8,98	2,20	3,37	6,42	8,98	0,83	1,65
PBA439(x/xx)-A	mm	175	240	56	85,6	235	300	21	42
	inch	6,89	9,45	2,20	3,37	9,25	11,81	0,83	1,65
PBA439(x/xx)-QB	mm	240	305	57	96,6	253	305	18	42
	inch	9,45	12,01	2,24	3,8	9,96	12,01	0,71	1,65
PBA439(x/xx)-BB	mm	235	300	57	96,6	335	400	18	42
	inch	9,25	11,81	2,24	3,8	13,19	15,75	0,71	1,65
PBA439(x/xx)-B	mm	335	400	59	100,1	435	500	18	42
	inch	13,19	15,75	2,32	3,94	17,13	19,69	0,71	1,65
PBA439(x/xx)-BC	mm	437	500	73	106,8	584	650	17	42
	inch	17,20	19,69	2,87	4,2	22,99	25,59	0,67	1,65
PBA439(x/xx)-CC	mm	503	600	85	128,3	724	800	18	42
	inch	19,80	23,62	3,35	5,05	28,5	31,50	0,71	1,65

\* : 1) d = minimale platformhoogte. Met de stelpoten van de weegschaal kan de platformhoogte met maximaal 10 mm / 0,39 inch worden vergroot.

2) Met de hygiënische kit-optie wordt de minimale platformhoogte (d) 12 mm / 0,47 inch groter.

## 6.5 Informatie over voorbelasting

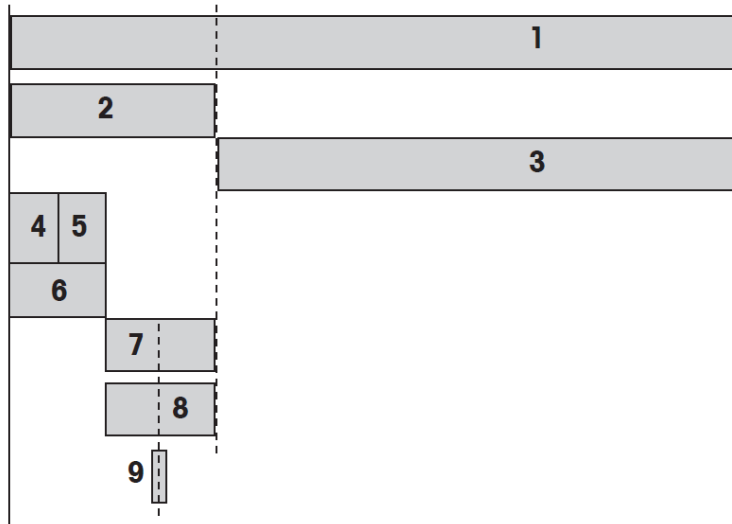

<b>1</b>	Maximaal belastingbereik van de weegcel ( $E_{max}$ )
<b>2</b>	Maximale voorbelasting = maximaal belastingbereik <b>1</b> – maximale belasting <b>3</b>
<b>3</b>	Maximale belasting = maximaal belastingbereik <b>1</b> – maximale voorbelasting <b>2</b>
<b>4</b>	Voorbelasting bovendeel
<b>5</b>	Voorbelasting weegpan
<b>6</b>	Voorbelasting af fabriek = voorbelasting bovendeel <b>4</b> + voorbelasting weegpan <b>5</b>
<b>7</b>	Mechanische voorbelastingreserve = maximale voorbelasting <b>2</b> – voorbelasting af fabriek <b>6</b>
<b>8</b>	Het nulpuntinstelbereik (bij inschakelen) kan worden ingesteld. Het nulpuntinstelbereik moet binnen de maximale voorbelasting liggen. Het nulpuntinstelbereik mag maximaal 18% van de maximale belasting bedragen.
<b>9</b>	Nulpuntinstelbereik $\pm 2\%$ van de maximale belasting

### 6.5.1 Voorbelastingtabel in kilogram

Type	Afmetingen [mm]	Max. belasting (3)	Voorbelasting boven-deel (4)	Voorbelasting weegpan (5)	Voorbelasting af fabriek (6)	Mech. Voorbelastingreserve (7)	Nulpuntinstelbereik (8)	Max. belastingbereik (1)
PBA439(x/xx)-QA3	228x228	3	1,04	0,95	1,99	6,01	0,54	11
PBA439(x/xx)-QA6	228x228	6	1,04	0,95	1,99	3,01	1,08	11
PBA439(x/xx)-A3	240x300	3	1,49	1,23	2,72	5,28	0,54	11
PBA439(x/xx)-A6	240x300	6	1,49	1,23	2,72	2,28	1,08	11
PBA439(x/xx)-A15	240x300	15	1,49	1,23	2,72	4,28	2,70	22
PBA439(x/xx)-QB15	305x305	15	1,70	1,51	3,21	3,79	2,70	22
PBA439(x/xx)-QB30	305x305	30	1,70	1,51	3,21	16,79	5,40	50
PBA439(x/xx)-QB60	305x305	60	1,70	1,51	3,21	36,79	10,80	100
PBA439(x/xx)-BB30	300x400	30	2,08	1,86	3,94	16,06	5,40	50
PBA439(x/xx)-BB60	300x400	60	2,08	1,86	3,94	36,06	10,80	100
PBA439(x/xx)-B30	400x500	30	3,45	2,85	6,30	13,70	5,40	50
PBA439(x/xx)-B60	400x500	60	3,45	2,85	6,30	33,70	10,80	100
PBA439(x/xx)-B150	400x500	150	3,45	2,85	6,30	43,70	27,00	200
PBA439(x/xx)-BC60	500x650	60	7,00	5,80	12,80	27,20	10,80	100
PBA439(x/xx)-BC150	500x650	150	7,00	5,80	12,80	35,00	27,00	250
PBA439(x/xx)-BC300	500x650	300	7,00	5,80	12,80	187,20	54,00	500
PBA439(x/xx)-CC60	600x800	60	9,36	11,00	20,36	19,64	10,80	100
PBA439(x/xx)-CC150	600x800	150	9,36	11,00	20,36	79,64	27,00	250
PBA439(x/xx)-CC300	600x800	300	9,36	11,00	20,36	179,64	54,00	500
PBA439(x/xx)-CC600	600x800	600	11,50	14,10	25,60	124,40	108,00	750

## 6.5.2 Voorbelastingtabel in ponden

Type	Afmetingen [inch]	Max. belasting (3)	Voorbelasting boven-deel (4)	Voorbelasting weegpan (5)	Voorbelasting af fabriek (6)	Mech. Voorbelastingreserve (7)	Nulpuntinstelbereik (8)	Max. belastingbereik (1)
PBA439(x/xx)-QA6	9x9	10	2,29	2,09	4,39	9,86	1,8	24
PBA439(x/xx)-A6	9,5x11,8	10	3,28	2,71	6,00	8,25	1,8	24
PBA439(x/xx)-A15	9,5x11,8	25	3,28	2,71	6,00	17,51	4,5	49
PBA439(x/xx)-QB15	12x12	25	3,75	3,33	7,08	16,42	4,5	49
PBA439(x/xx)-QB30	12x12	50	3,75	3,33	7,08	53,15	9,0	110
PBA439(x/xx)-QB60	12x12	100	3,75	3,33	7,08	113,39	18,0	220
PBA439(x/xx)-BB30	11,8x15,7	50	4,59	4,10	8,69	51,54	9,0	110
PBA439(x/xx)-BB60	11,8x15,7	100	4,59	4,10	8,69	111,78	18,0	220
PBA439(x/xx)-B30	15,7x19,7	50	7,61	6,28	13,89	46,34	9,0	110
PBA439(x/xx)-B60	15,7x19,7	100	7,61	6,28	13,89	106,57	18,0	220
PBA439(x/xx)-B150	15,7x19,7	250	7,61	6,28	13,89	177,04	45,0	441
PBA439(x/xx)-BC60	19,7x25,6	100	15,43	12,79	28,22	92,24	18,0	220
PBA439(x/xx)-BC150	19,7x25,6	250	15,43	12,79	28,22	157,86	45,0	551
PBA439(x/xx)-BC300	19,7x25,6	500	15,43	12,79	28,22	574,09	90,0	1102
PBA439(x/xx)-CC60	23,6x29,5	100	20,64	24,25	44,89	75,58	18,0	220
PBA439(x/xx)-CC150	23,6x29,5	250	20,64	24,25	44,89	256,27	45,0	551
PBA439(x/xx)-CC300	23,6x29,5	500	20,64	24,25	44,89	557,43	90,0	1102
PBA439(x/xx)-CC600	23,6x29,5	1000	25,35	31,09	56,44	597,03	180,0	1653

## 6.6 Accessoires

### Kolom

Artikelnr.	Benaming	Beschrijving
72229393	Kolom open 120 mm / 4,7"	Geschikt voor alle platformafmetingen
72198702	Kolom open 330 mm / 13"	Geschikt voor alle platformafmetingen
72198703	Kolom open 660 mm / 26"	Geschikt voor alle platformafmetingen
72198704	Kolom open 900 mm / 35,4"	Geschikt voor alle platformafmetingen groter dan maat A

### Roestvrij stalen kar

Artikelnr.	Benaming	Beschrijving
72225939	Roestvrij stalen kar BC	Geschikt voor platformafmeting maat BC
72225940	Roestvrij stalen kar CC	Geschikt voor platformafmeting maat CC

### Rollenbaan

Artikelnr.	Benaming	Beschrijving
30253326	Rollenbaan 400 × 500 mm / 15,7" × 19,7" roestvrij staal	Geschikt voor platformafmeting maat B. Rollen aan korte zijde van het platform
30253328	Rollenbaan 500 × 650 mm / 19,7" × 25,6" roestvrij staal	Geschikt voor platformafmeting maat BC. Rollen aan korte zijde van het platform
30253330	Rollenbaan 600 × 800 mm / 23,6" × 31,5" roestvrij staal	Geschikt voor platformafmeting maat CC. Rollen aan korte zijde van het platform
30253327	Rollenbaan 400 × 500 mm / 15,7" × 19,7" roestvrij staal	Geschikt voor platformafmeting maat B. Rollen aan lange zijde van het platform
30253329	Rollenbaan 500 × 650 mm / 19,7" × 25,6" roestvrij staal	Geschikt voor platformafmeting maat BC. Rollen aan lange zijde van het platform
30253331	Rollenbaan 600 × 800 mm / 23,6" × 31,5" roestvrij staal	Geschikt voor platformafmeting maat CC. Rollen aan lange zijde van het platform
30640393	Rollenbaan 400 × 500 mm / 15,7" × 19,7" roestvrij staal	Geschikt voor explosiegevaarlijk gebied
30640394	Rollenbaan 500 × 650 mm / 19,7" × 25,6" roestvrij staal	Geschikt voor explosiegevaarlijk gebied
30640395	Rollenbaan 600 × 800 mm / 23,6" × 31,5" roestvrij staal	Geschikt voor explosiegevaarlijk gebied

### Montagesteun voorzijde

Artikelnr.	Benaming	Beschrijving
22021062	Montagesteun voorzijde	Geschikt voor ICS4_9 montage voorzijde

### Roestvrij stalen weegplateau

Artikelnr.	Benaming	Beschrijving
30676769	AISI 316 roestvrij stalen weegplateau 240 x 300 mm / 9,5" x 11,8"	Geschikt voor platformafmeting maat A
30676770	AISI 316 roestvrij stalen weegplateau 300 x 400 mm / 11,8" x 15,7"	Geschikt voor platformafmeting maat BB
30676771	AISI 316 roestvrij stalen weegplateau 400 x 500 mm / 15,7" x 19,7"	Geschikt voor platformafmeting maat B
30676772	AISI 316 roestvrij stalen weegplateau 228 x 228 mm / 9" x 9"	Geschikt voor platformafmeting maat QA
30676773	AISI 316 roestvrij stalen weegplateau 305 x 305 mm / 12" x 12"	Geschikt voor platformafmeting maat QB
30676774	AISI 316 roestvrij stalen weegplateau 500 x 650 mm / 19,7" x 25,6"	Geschikt voor platformafmeting maat BC

Artikelnr.	Benaming	Beschrijving
30676775	AISI 316 roestvrij stalen weegplateau, dikte 2,0 mm, 600 x 800 mm / 23,6" x 31,5"	Geschikt voor platformafmeting maat CC
30676776	AISI 316 roestvrij stalen weegplateau, dikte 2,5 mm, 600 x 800 mm / 23,6" x 31,5"	Geschikt voor platformafmeting maat CC

## 7 Montagemogelijkheden

Het PBA439(x/xx) is geschikt voor montage op een stabiele ondergrond. Gebruik onderstaan boorpatroon wanneer in het weegplatform moet worden geboord.

**OPMERKING: De gearceerde gebieden geven aan waar in het weegplatform mag worden geboord.**

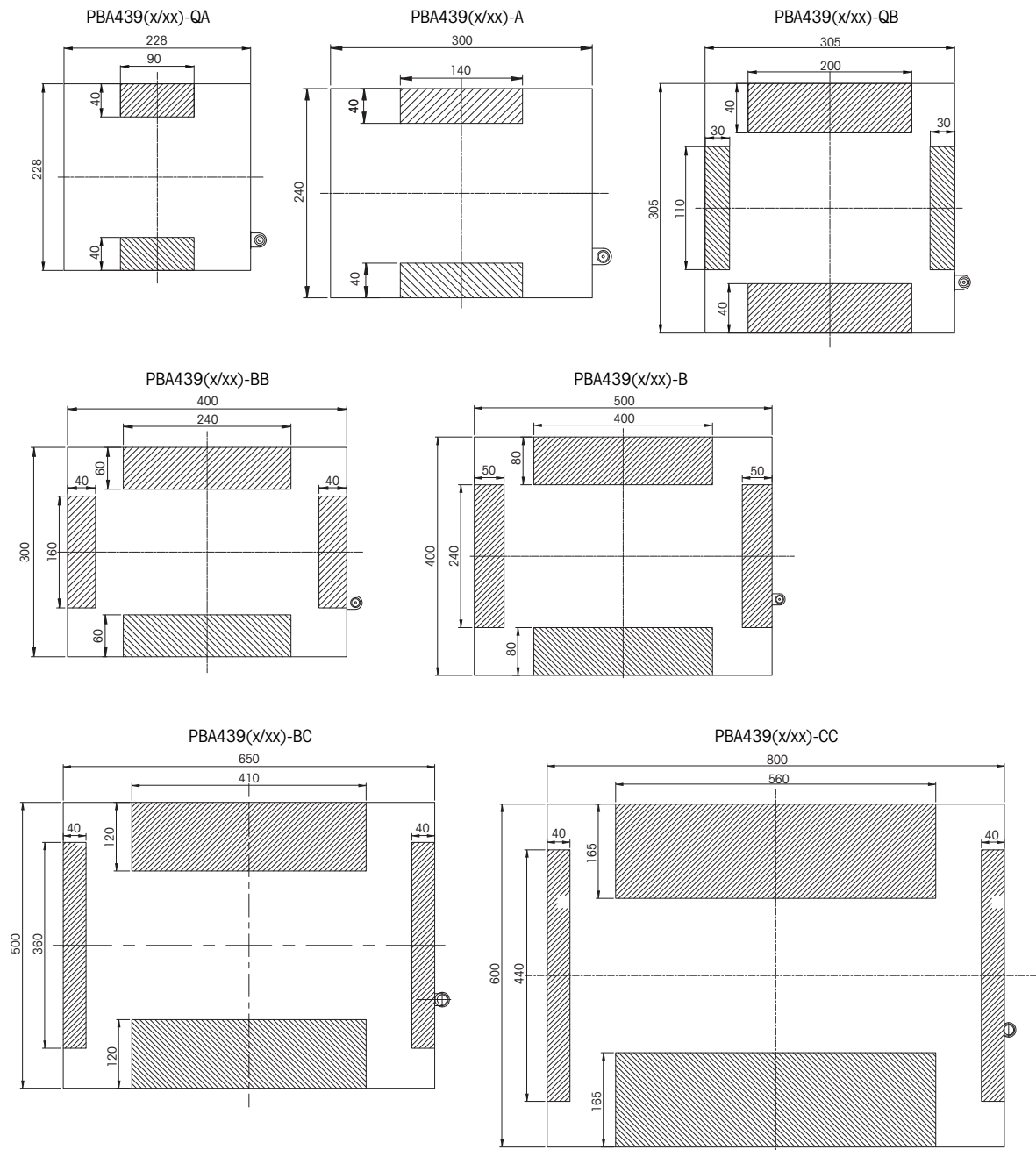

Gemeten in [mm]









## 8 Bijlage

### 8.1 Etiket

<p>IS CL I,II,III DIV 1, GP ABCDEFG T6...T4          Class I, Zone 1, AEx ia IIC T6...T4 Gb          Class II,III, Zone 21, AEx ia IIIC T80°C Db          -40°C ≤ Ta ≤ 60°C T5/T4; -40°C ≤ Ta ≤ 40°C T6          FM21US0076X</p>	 <p>C APPROVED US IP67</p>	<p> II 2G Ex ia IIC T6...T4 Gb   II 2D Ex ia IIIC T80°C Db          -40°C ≤ Ta ≤ 60°C T5/T4          -40°C ≤ Ta ≤ 40°C T6</p>
<p>IS CL I,II,III DIV 1, GP ABCDEFG T6...T4          Class I, Zone 1, Ex ia IIC T6...T4 Gb          Class II,III, Zone 21, Ex ia IIIC T80°C Db          -40°C ≤ Ta ≤ 60°C T5/T4; -40°C ≤ Ta ≤ 40°C T6          FM21CA0051X</p>		<p>Entity/NIFW for NonIncendive Field Wiring. Entity parameters are shown in drawing 30688074          Mettler-Toledo GmbH, Im Langacher 44, 8606 Greifensee, Switzerland</p>

<p>NI CL I,II,III DIV 2 GP ABCDEFG T6          -40°C ≤ Ta ≤ 60°C          FM21US0076X</p>	 <p>C APPROVED US IP67</p>	<p> II 3G Ex ic IIC T6...T4 Gc          -40°C ≤ Ta ≤ 60°C T5/T4          -40°C ≤ Ta ≤ 40°C T6</p>
<p>NI CL I,II,III DIV 2 GP ABCDEFG T6...T4          -40°C ≤ Ta ≤ 60°C          Class I, Zone 2, Ex ec IIC T6 Gc;          Class II,III, Zone 22, Ex tc IIIC T80°C Dc          FM21CA0051X</p>		<p> II 3G Ex ec IIC T6 Gc U<sub>rated</sub>=20V   II 3D Ex tc IIIC T80°C Dc I<sub>rated</sub>=50mA   -40°C ≤ Ta ≤ 60°C</p>
		<p>Entity/NIFW for NonIncendive Field Wiring. Entity parameters are shown in drawing 30688074          Mettler-Toledo GmbH, Im Langacher 44, 8606 Greifensee, Switzerland</p>



## 8.2 Besturingschema

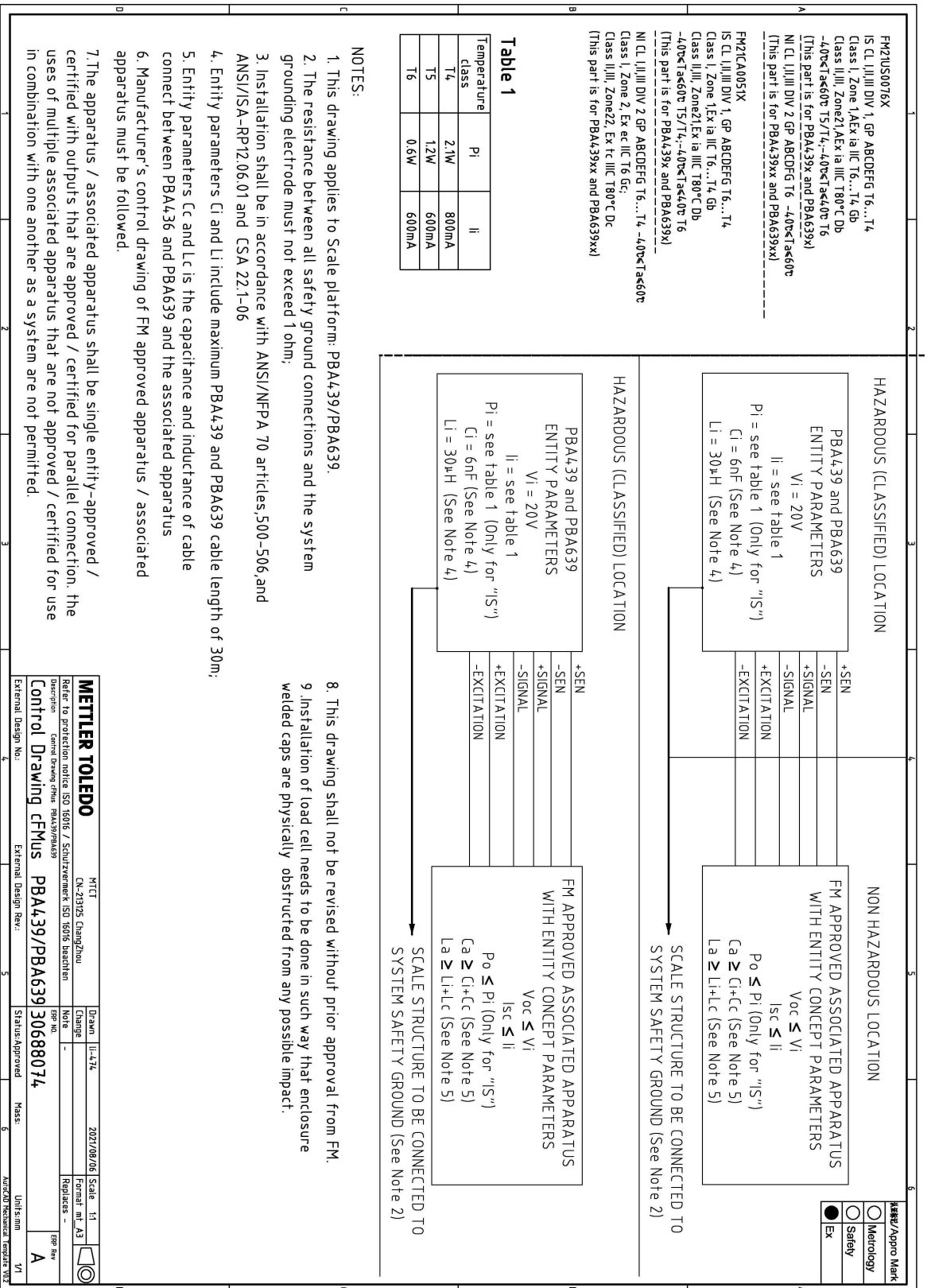

<b>METTLER TOLEDO</b>		MITT	
Refer to protection notice ISO 16016 / Schutzanweisung ISO 16016 Shenzhen		CN-213725 Changzhou	
General Drawing plus PBA439/PBA639		Schutzanweisung ISO 16016 Shenzhen	
Description	Control Drawing cFMus	Part No.	PBA439/PBA639 30688074
External Design No.	External Design Rev.	Status/Approved	Mass
1	2	3	4
Unit/Scale		Unit/Scale	
mm / 1:1		mm / 1:1	
Date		Date	
2021/08/06		2021/08/06	
Drawn		Scale	
li-474		1:1	
Change		Format	
-		m1 A3	
Note		Replaces	
-		-	
GPR No.		GPR Rev	
-		A	
External Design No.		Unit/Scale	
-		mm / 1:1	

### 8.3 Installatietekening

#### Hazardous (Classified) Location

IP67 II 3G Ex ic IIC T6...T4 Gc  
-40°C ≤ T<sub>a</sub> ≤ 60°C T5/T4; -40°C ≤ T<sub>a</sub> ≤ 40°C T6

II 3G Ex ec IIC T6 Gc -40°C ≤ T<sub>a</sub> ≤ 60°C T6  
II 3D Ex tc IIC T80°C Dc  
FM21UKEX0080X  
FM21ATEX0025X IECEX FMG21.0003X

---

II 2G Ex ia IIC T6...T4 Gb  
-40°C ≤ T<sub>a</sub> ≤ 60°C T5/T4; -40°C ≤ T<sub>a</sub> ≤ 40°C T6

II 2D Ex ia IIC T80°C Db  
FM21UKEX0079X  
FM21ATEX0003X IECEX FMG21.0003X

**Approval Mark**

THIS ITEM IS PART OF AGENCY APPROVED PRODUCT

Metrology  
 Safety  
 Ex

DO NOT CHANGE DOCUMENT WITHOUT APPROPRIATE APPROVAL

SLP84x Load Cell

U<sub>i</sub> = 20V  
I<sub>i</sub> = see table 2  
P<sub>i</sub> = see table 2  
C<sub>i</sub> = 6nF  
L<sub>i</sub> = 30uH

Ex Approved Associated Apparatus with Entity Concept Parameters

U<sub>o</sub> ≤ U<sub>i</sub>  
I<sub>o</sub> ≤ I<sub>i</sub>  
P<sub>o</sub> ≤ P<sub>i</sub>  
C<sub>o</sub> ≥ C<sub>c</sub>+C<sub>i</sub>  
L<sub>o</sub> ≥ L<sub>c</sub>+L<sub>i</sub>

Scale structure (attached to load cell) to be connected to system safety ground. See Note.

**NOTES:**

- The resistance between all safety ground connections and the system grounding electrode must not exceed 1ohm.
- Installation shall be in accordance with relevant electrical installation standards (Being shown in Table 1) in hazardous areas (other than mines).
- Entity Parameters C<sub>i</sub> And L<sub>i</sub> Include Maximum Load Cell Cable Length Of 30m
- Entity Parameters C<sub>c</sub> and L<sub>c</sub> is the capacitance and inductance of cable connect between load cell and the associated apparatus.
- In an explosive atmosphere caused by air/dust mixtures, the loose ends of the cable shall be connected outside the hazardous area or in a suitable enclosure with a degree of protection of at least IP6X in accordance with EN 60529.
- For the application of Ex ec, Ex tc: U<sub>rated</sub>=20V, I<sub>rated</sub>=50mA.
- Installation of load cell needs to be done in such way that enclosure welded caps are physically obstructed from any possible impact.
- ⚠ Not following these instructions will jeopardize the explosion safety.
- For the application of Ex ec, The equipment shall only be used in an area of at least pollution degree 2, as defined in IEC 60664-1.

Table 1

EN60079-0: 2018	EN60079-14: 2014	EN60079-11: 2012	EN60079-31: 2014
EN61241-14: 2004	EN60079-31: 2013	EN60079-7: 2015	IEC60079-31: 2013
IEC 60079-0-2017	IEC 60079-11-2011	IEC 60079-14-2013	IEC60079-7: 2015

Table 2

Temperature class	P <sub>i</sub>	I <sub>i</sub>
T4	2.1W	800mA
T5	1.2W	600mA
T6	0.6W	600mA

Mettler-Toledo GmbH, Im Langacher 44, 8606 Greifensee, Switzerland  
Mettler-Toledo Ltd. 64 Boston Rd. Leicester, LE4 1AW, United Kingdom

D	update drawing status	Wang Jianwen	Liu Yuchun				2021-7-26	
C	removed Ex nA of note 6	Wang Jianwen	Liu Yuchun				2021-1-15	
REV / CHG	DESCRIPTION	BY	APPVD	AGENCY	E.R. No.	DATE		
RECORD OF CHANGES								
<b>METTLER TOLEDO</b>		MTCZ	Drawn	Wang JW	2020/05/11	Scale	1:1	
		CN-213022 ChangZhou	Change			Format	mt_A4	
Refer to protection notice ISO 16016 / Schutzvermerk ISO 16016 beachten		Note	-			Replaces	-	
Description 防爆安装图 SLP84X		ERP NO.					ERP Rev	
<b>INSTALLATION DRAWING SLP84X ATEX/IECEX</b>		30555321				D		
External Design No.: D000644580		External Design Rev.: D		Status: Approved	Mass:	Units: mm	1/1	

AutoCAD Mechanical Template V0.2





# METTLER TOLEDO Service

Parabéns por escolher a qualidade e a precisão da METTLER TOLEDO. O uso correto do seu novo equipamento de acordo com este Manual, bem como calibrações e manutenções regulares por nossa equipe treinada de fábrica garantem uma operação precisa e confiável para proteger o seu investimento. Fale conosco sobre um contrato de serviço personalizado às suas necessidades e orçamento. Outras informações estão disponíveis em ► [www.mt.com/service](http://www.mt.com/service).

Há várias maneiras importantes de garantir que você aumente o desempenho do seu investimento:

- 1 **Registre seu produto:** Nós o convidamos a registrar seu produto em [www.mt.com/productregistration](http://www.mt.com/productregistration) para que possamos falar com você sobre melhorias, novidades e notificações importantes sobre o produto.
- 2 **Entre em contato com a METTLER TOLEDO para obter atendimento:** O valor de uma medida é proporcional à sua precisão. Uma balança fora das especificações pode reduzir a qualidade, os lucros e aumentar os riscos. O atendimento em tempo hábil da METTLER TOLEDO garantirá a precisão e otimizará o tempo de atividade e a vida útil do equipamento.
  - ➔ **Instalação, configuração, integração e treinamento:** Nossos representantes de atendimento são especialistas treinados de fábrica em equipamentos de pesagem. Nós garantimos que seu equipamento de pesagem esteja pronto para produção, de maneira econômica e oportuna, e que o pessoal seja treinado para o êxito.
  - ➔ **Documentação inicial de calibração:** O ambiente de instalação e as exigências de aplicação são específicos para cada balança industrial. Sendo assim, o desempenho deve ser testado e certificado. Nossos serviços e certificados de calibração documentam a precisão, garantindo a qualidade da produção e fornecendo o registro de desempenho de um sistema de qualidade.
  - ➔ **Manutenção periódica de calibração:** Um Contrato de serviço de calibração oferece confiança contínua no seu processo de pesagem, bem como a comprovação de conformidade com os requisitos. Oferecemos diversos planos de serviço programados para atender às suas necessidades e desenvolvidos para caber no seu orçamento.



# Índice remissivo

<b>1</b>	<b>Instruções de segurança</b>	<b>3</b>
1.1	Utilização prevista.....	3
1.2	Uso indevido .....	3
1.3	Precauções de segurança.....	3
1.4	Condições específicas de uso .....	3
<b>2</b>	<b>Introdução</b>	<b>4</b>
2.1	Seleção .....	4
2.2	Sobre este manual .....	4
2.3	Documentos adicionais .....	4
<b>3</b>	<b>Instalação e operação</b>	<b>5</b>
3.1	Conectar a plataforma de pesagem ao terminal de pesagem .....	5
3.2	Nivelamento .....	6
3.3	Ligação equipotencial .....	6
3.4	Verificar a plataforma de pesagem.....	6
3.5	Operação da plataforma de pesagem.....	7
3.6	Instalação, configuração, manutenção e reparo .....	7
<b>4</b>	<b>Manutenção</b>	<b>8</b>
4.1	Observações sobre limpeza .....	8
4.2	Tratamento subsequente.....	8
4.3	Descarte de resíduos .....	9
<b>5</b>	<b>Reparar</b>	<b>10</b>
<b>6</b>	<b>Dados técnicos e limites operacionais</b>	<b>11</b>
6.1	Intervalo de verificação máximo da balança .....	11
6.2	Carga máxima permitida .....	11
6.3	Dados técnicos da célula de carga .....	12
6.3.1	Aprovação Ex .....	12
6.3.2	Padrão de conformidade de célula de carga .....	12
6.4	Dimensões.....	14
6.5	Informações sobre pré-carga de capacidade.....	15
6.5.1	Tabela de pré-carga em quilogramas .....	16
6.5.2	Tabela de pré-carga em libras .....	17
6.6	Acessórios .....	18
<b>7</b>	<b>Possibilidades de montagem</b>	<b>20</b>
<b>8</b>	<b>Apêndice</b>	<b>21</b>
8.1	Etiqueta .....	21
8.2	Desenho de controle .....	22
8.3	Desenho de instalação .....	23





# 1 Instruções de segurança

## 1.1 Utilização prevista

As plataformas de pesagem PBA439(x/xx) fazem parte de um sistema modular de pesagem que consiste em um terminal de pesagem METTLER TOLEDO como indicador e, no mínimo, uma plataforma de pesagem.

- Use a plataforma de pesagem apenas para pesar, de acordo com este manual.
- A plataforma de pesagem só deve ser usada em ambientes fechados.
- Apenas a plataforma de pesagem PBA439x/xx é adequada para uso em ambientes perigosos, conforme especificado abaixo.
- Qualquer outro tipo de uso é considerado não pretendido.

### Metrologia legal

- Para uso em metrologia legal, use apenas as plataformas de pesagem aprovadas.
- Ao usar em metrologia legal, a empresa operadora é responsável por observar todas as exigências nacionais de pesos e medidas.
- Por favor, contate a organização de serviço da METTLER TOLEDO para questões relacionadas ao uso em aplicações legais para o comércio.

## 1.2 Uso indevido

- Use o terminal de pesagem apenas para operações de pesagem.
- Não use a plataforma de pesagem em ambientes não especificados na --- MISSING LINK ---.
- Não altere a plataforma de pesagem.
- Não use o terminal de pesagem fora dos limites das especificações técnicas.
- Não use a plataforma de pesagem para armazenar mercadorias.
- Evite a queda de itens sobre a plataforma de pesagem.

## 1.3 Precauções de segurança

- Apenas o pessoal treinado e qualificado pela METTLER TOLEDO pode instalar e fazer a manutenção da plataforma de pesagem.
- Tenha cuidado ao transportar ou levantar dispositivos pesados.
- Sempre desconecte a plataforma de pesagem da fonte de alimentação antes de instalar, limpar ou fazer a manutenção.
- O cabo de conexão não pode ser desconectado do terminal de pesagem enquanto estiver energizado.
- Certifique-se de que a plataforma de pesagem atingiu a temperatura ambiente antes de ligar a fonte de alimentação.
- As plataformas de pesagem protegidas contra explosões PBA439x/xx são aprovadas para operação nas seguintes áreas de risco:
  - ATEX/IECEx Categoria 2, Categoria 3, gás/poeira (Zona 1/21, Zona 2/22)
  - cFMus, Classe I,II,III, Div. 1, Div. 2
- Há um aumento no risco de ferimentos e danos quando as plataformas de pesagem são usadas em áreas de risco! Deve-se ter cautela especial ao trabalhar em tais áreas.
- No caso da plataforma de pesagem PBA439x/xx, use apenas prensa-cabos adequados e aprovados para áreas perigosas para inserir o cabo da célula de pesagem no terminal de pesagem.
- Plataformas de pesagem protegidas contra explosões só podem ser usadas em áreas de risco juntamente com terminais de pesagem com a aprovação e especificação de interface adequadas.

## 1.4 Condições específicas de uso

- Em uma atmosfera explosiva causada pela umidade do ar / poeira, as pontas soltas do cabo devem ser conectadas fora da área de risco ou em um invólucro adequado com um grau de proteção de pelo menos IP6X de acordo com IEC / EN 60529.

## 2 Introdução

### 2.1 Seleção

Este Manual destaca o produto da série PBA439(x/xx).

A série PBA439(x/xx) oferece diversas plataformas de pesagem para atender às suas exigências. Ela é aprovável e oferece diversos tamanhos e capacidades

Tipo	Material da placa de carga	Material da estrutura da balança	Design da célula de carga	Proteção IP ambiente	Aprovação para áreas perigosas
PBA439	Aço inoxidável AISI304	Aço inoxidável AISI304	Aço inoxidável, hermeticamente selado	Seco, molhado, IP68/IP69K	-
PBA439x					Zona 1/21, Div 1
PBA439xx					Zona 2/22, Div 2

### 2.2 Sobre este manual



Este manual contém todas as informações para o operador do produto.

- Leia cuidadosamente este manual antes de usar.
- Guarde este manual para futuras consultas.
- Repasse este manual para possíveis proprietários ou usuários futuros do produto.

### 2.3 Documentos adicionais

Além deste Manual, é possível fazer o download dos seguintes documentos em ► [www.mt.com](http://www.mt.com):

- Brochura
- Informações sobre instalação (para pessoal treinado sob a supervisão da empresa operadora)
- Documentos dos tipos de aprovação

#### Download de certificado

Os certificados dos EUA, Canadá, ATEX, UKEX e IECEx podem ser baixados de

► <https://www.mt.com/us/en/home/search/compliance.html/compliance/>.

## 3 Instalação e operação

### 3.1 Conectar a plataforma de pesagem ao terminal de pesagem

As plataformas de pesagem PBA439(x/xx) são destinadas ao uso com terminais de pesagem METTLER TOLEDO analógicos.

- 1 Insira o cabo da plataforma de pesagem no terminal de pesagem por meio do prensa-cabo.
- 2 Conecte o cabo da plataforma de pesagem ao bloco de terminais do terminal de pesagem, de acordo com a tabela a seguir.

Sinal	Cor do fio	Conector
SIG+	Branco	<p><b>CÉLULAS DE 6 FIOS</b></p> <p>1 7</p> <p>+EXC +SEN +SIG SHIELD -SIG -SEN -EXC</p> <p>CÉLULA DE CARGA OU CAIXA DE JUNÇÃO</p>
SIG-	Vermelho	
EXC+	Verde	
EXC-	Preto	
SEN+	Amarelo	
SEN-	Azul	



#### ATENÇÃO

A blindagem do cabo deve ser aterrada.

#### Precauções de segurança para conexões

- Ao conectar a plataforma de pesagem em área perigosa, siga estritamente os requisitos indicados no desenho de controle disponível no [Apêndice ► página 21].
- Verifique as condições especiais para uso seguro nos desenhos e certificados no [Apêndice ► página 21].
- A blindagem do cabo é conectada ao elemento de mola da célula de carga (o corpo da célula de carga). Considere a conexão apropriada entre a célula de carga e o terminal (ou caixa de junção) com base no cenário de instalação.
- A resistência entre todas as conexões de aterramento de segurança e o eletrodo de aterramento do sistema não deve exceder 1 ohm.
- A instalação deve estar de acordo com os padrões de instalação elétrica relevantes.
- O não cumprimento dessas instruções prejudicará a segurança contra explosão.

## 3.2 Nivelamento

Apenas uma plataforma de pesagem alinhada horizontalmente, de maneira exata, fornece resultados exatos de pesagem. A plataforma de pesagem precisa ser nivelada durante a instalação inicial e sempre que mudar de local.

- 1 Gire o pé ajustável da plataforma de pesagem até que a bolha de ar do nível ideal esteja dentro do círculo interno.
- 2 Aperte as contraporcas do pé ajustável.

👉 **Escaneie o código QR para assistir ao vídeo**

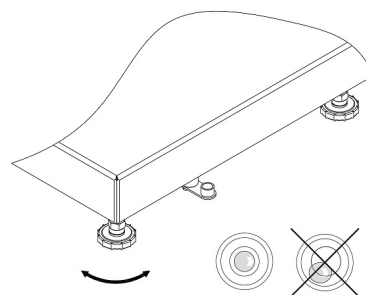

## 3.3 Ligação equipotencial

A ligação equipotencial das plataformas de pesagem PBA439x/xx é montada na fábrica. A instalação elétrica deve ser feita por um electricista profissional nas instalações do cliente. O serviço da METTLER TOLEDO tem a função de monitoramento e consultoria somente aqui. Conecte a ligação equipotencial (PA) de todos os dispositivos (plataforma de pesagem e terminal de pesagem) de acordo com os regulamentos e padrões específicos do país. No processo, certifique-se de que todas as caixas do dispositivo estejam conectadas no mesmo potencial por meio do terminal PA.

### Observação

O equipamento é protegido contra choque elétrico de acordo com IEC60950, classe II.

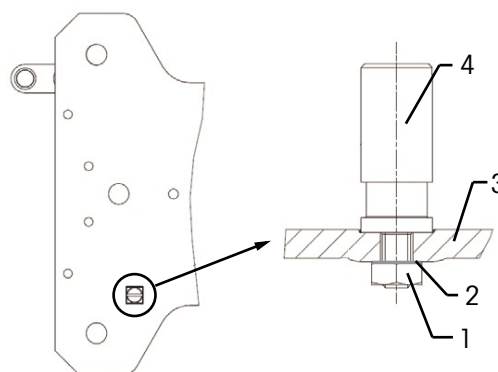

- 1 - Porca de travamento hexagonal, M4 KEPS
- 2 - Arruela
- 3 - Estrutura da Base
- 4 - Terminal de ligação equipotencial, torque 3,5 Nm

Número de pedido do kit de ligação equipotencial 72237321

## 3.4 Verificar a plataforma de pesagem

### Verificação de função

- 1 Certifique-se de que a plataforma de pesagem está ligada a um terminal de pesagem e de que ele está ligado.
- 2 Certifique-se de que a plataforma de pesagem está descarregada e que a tela do terminal de pesagem mostra 0.
- 3 Carregue a plataforma de pesagem. O terminal de pesagem deve mostrar um valor diferente de 0.
- 4 Descarregue a plataforma de pesagem. O terminal de pesagem deve voltar a 0.

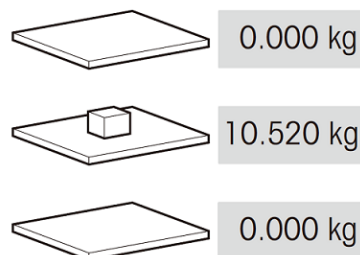

### Teste de verificação

Para um teste de verificação, consulte o manual do usuário do terminal de pesagem conectado. Se o selo de verificação estiver quebrado, a verificação não é mais válida.

### 3.5 Operação da plataforma de pesagem

Para obter os melhores resultados de pesagem, observe os seguintes pontos:

- Certifique-se de que a placa de carga está bem colocada.

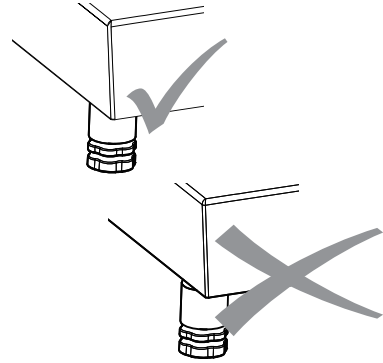

- Para conseguir os melhores resultados de pesagem, coloque a amostra de pesagem sempre na mesma posição na plataforma de pesagem.

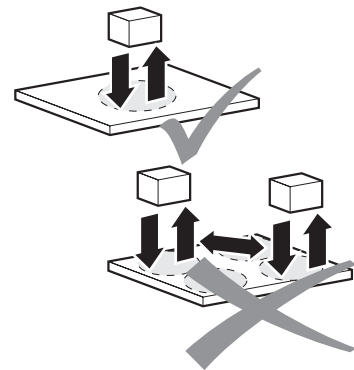

- Evite processos abrasivos e de desgaste.

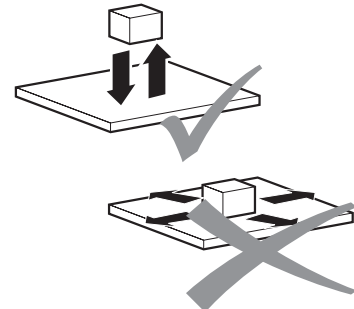

- Evite a queda de cargas, choques e impactos laterais.

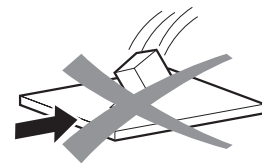

### 3.6 Instalação, configuração, manutenção e reparo

Para a instalação, configuração, manutenção e reparo das plataformas de pesagem, ligue para o serviço da METTLER TOLEDO.

## 4 Manutenção

### 4.1 Observações sobre limpeza

#### Nota

#### Danos à plataforma de pesagem devido ao uso incorreto de agentes de limpeza.

- Só utilize desinfetantes e agentes de limpeza de acordo com as instruções do respectivo fabricante.
- Não use agentes de limpeza altamente ácidos, altamente alcalinos ou altamente clorados. Evite substâncias com valor alto ou baixo de pH, caso contrário, haverá grande risco de corrosão.
- Tenha cuidado especial ao limpar a célula de carga.

#### Procedimento de limpeza

- Remova a sujeira e sedimentos das partes externa e interna da plataforma de pesagem em intervalos regulares.
  - ➔ O procedimento depende tanto do tipo de superfície como das condições ambientais existentes no local da instalação.

#### Limpeza em ambiente úmido (versões em aço inoxidável)

- Use um jato de água de até 80 °C / 176 °F e, no máx., 80 bars, a uma distância mínima de 40 cm / 16".
- Use agentes de limpeza domésticos.

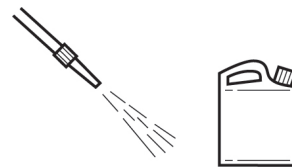

#### Limpeza em ambiente corrosivo (versões em aço inoxidável)

- Use um jato de água.
  - Limpeza interna**, célula de carga, placa de carga aberta: até 60 °C / 140 °F e máx. 2 barras, distância mínima de 40 cm / 16".
  - Limpeza externa**, plataforma de carga fechada: a 80 °C / 176 °F e máx. 80 bars, distância mínima de 40 cm / 16".
- Remova substâncias corrosivas em intervalos regulares.
- Só utilize desinfetantes e agentes de limpeza de acordo com as especificações e instruções do respectivo fabricante

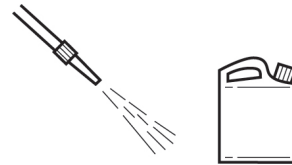

### 4.2 Tratamento subsequente

Para proteger a balança, siga o seguinte tratamento subsequente:

- Enxague a balança com água limpa e remova totalmente o agente de limpeza.
- Seque a balança com um pano que não solte fiapos.
- No caso das balanças em aço inoxidável, trate as partes interna e externa com óleo adequado para alimentos.

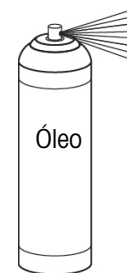

### 4.3 Descarte de resíduos

Em conformidade com a Diretiva Europeia 2012/19/EU sobre Descarte de Equipamentos Elétricos e Eletrônicos (WEEE), esse dispositivo não pode ser descartado como resíduo doméstico. Isso também se aplica a países fora da UE segundo seus requisitos específicos.

Descarte este produto de acordo com as regulamentações locais no ponto de coleta especificado para equipamento elétrico e eletrônico. Se tiver qualquer dúvida, entre em contato com a autoridade responsável ou o destruidor do qual comprou este dispositivo. Caso esse dispositivo seja repassado a terceiros, o conteúdo dessa regulamentação também deve ser observado.



## **5 Reparar**

Este equipamento é certificado para uso em locais perigosos, portanto, nenhuma modificação é permitida. Os reparos devem ser realizados apenas por pessoal especificamente treinado para reparos deste equipamento.



## 6 Dados técnicos e limites operacionais

### 6.1 Intervalo de verificação máximo da balança

Intervalo de verificação máximo da balança [e] / OIML	Capacidade							
	3 kg	6 kg	15 kg	30 kg	60 kg	150 kg	300 kg	600 kg
1 x 3000e Max / e [kg]	3 / 0.001	6 / 0.002	15 / 0.005	30 / 0.01	60 / 0.02	150 / 0.05	300 / 0.1	600 / 0.2

Intervalo de verificação máximo da balança [d] / NTEP	Capacidade							
	-	10 lb	25 lb	50 lb	100 lb	250 lb	500 lb	1000 lb
1 x 5000d Max / d [lb]	-	10 / 0.002	25 / 0.005	50 / 0.01	100 / 0.02	250 / 0.05	500 / 0.1	1000 / 0.2

### 6.2 Carga máxima permitida

Todas as plataformas de pesagem estão equipadas com uma proteção de sobrecarga. Com o design robusto da balança, ocasionalmente, você pode ultrapassar a capacidade determinada da plataforma sem que danos ocorram. A carga de segurança estática máxima nunca deve ser excedida.

- Observe os seguintes limites de operação.

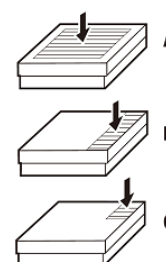

Modelo	A - Carga central	B - Carga lateral	C - Carga de canto
PBA439(x/xx)-QA	40 kg / 80 lb	30 kg / 60 lb	15 kg / 30 lb
PBA439(x/xx)-A	40 kg / 80 lb	30 kg / 60 lb	15 kg / 30 lb
PBA439(x/xx)-QB	100 kg / 200 lb	70 kg / 140 lb	35 kg / 70 lb
PBA439(x/xx)-BB	100 kg / 200 lb	70 kg / 140 lb	35 kg / 70 lb
PBA439(x/xx)-B	200 kg / 400 lb	140 kg / 280 lb	75 kg / 150 lb
PBA439(x/xx)-BC	400 kg / 800 lb	300 kg / 600 lb	150 kg / 300 lb
PBA439(x/xx)-CC	700 kg / 1400 lb	400 kg / 800 lb	200 kg / 400 lb



#### **ATENÇÃO**

Evite a queda e o choque de cargas, bem como impactos laterais.

### 6.3 Dados técnicos da célula de carga

Saída classificada	mV/V	1,8 ± 0,2
Resistência de entrada	Ω	384 ± 15
Resistência de saída	Ω	350 ± 4
Tensão recomendada	V (CC / CA)	5 - 15
Máx. tensão excitada	V (CC / CA)	20
Bainha de cabo	-	PVC
Classificação do IP	-	IP68/IP69K

#### 6.3.1 Aprovação Ex

Esta seção cobre apenas os aspectos Ex relevantes do produto.

A célula de carga SLP84x (x = 6,7,8) foi concedida com:

Certificado ATEX	FM21ATEX0003X, FM21ATEX0025X
Certificado UK	FM21UKEX0079X, FM21UKEX0080X
Certificado IECEx	IECEX FMG21.0003X
Certificado US	FM21US0005X
Certificado canadense	FM21CA0002X

Os certificados listados acima e os desenhos de instalação relacionados, consulte o [Apêndice ► página 21].

#### 6.3.2 Padrão de conformidade de célula de carga

##### Padrões dos EUA

Título	Número	Data de emissão
Equipamento elétrico para uso em locais perigosos (classificados) – Requisitos gerais	FM Classe 3600	2018
Aparelho intrinsecamente seguro e aparelho associado para uso em Classe I, II e III, Divisão 1, Locais Perigosos (Classificados)	FM Classe 3610	2021
Equipamento elétrico não inflamável para uso em classes I e II, divisão 2 e classe III, divisões 1 e 2, locais perigosos (classificados)	FM Classe 3611	2021
Equipamento elétrico para medição, controle e uso de laboratório	FM Classe 3810	2021
Atmosferas explosivas - Parte 0: Equipamento - Requisitos gerais	ANSI/UL 60079-0	2019
Atmosferas explosivas – Parte 11: Proteção do equipamento por segurança intrínseca "i"	ANSI/ISA 60079-11	2014
Equipamento elétrico não inflamável para uso em classes I e II, divisão 2 e classe III, divisões 1 e 2, locais perigosos (classificados)	ANSI/UL 121201	2017
Requisitos de segurança para equipamentos elétricos para medição, controle e uso em laboratório – Parte 1: Requerimentos gerais	ANSI/UL 61010-1	2012
Graus de proteção fornecidos por gabinetes (código IP)	ANSI/IEC 60529	2020

##### Padrões canadenses

Título	Número	Data de emissão
Equipamento elétrico antideflagrante para uso em locais perigosos de Classe I, Divisão 2	CSA C22.2 No. 213	2017
Atmosferas explosivas - Parte 0: Equipamento - Requisitos gerais	CAN/CSA-C22.2 N.º 60079-0	2019
Atmosferas explosivas - Parte 11: Proteção do equipamento por segurança intrínseca "i"	CAN/CSA-C22.2 N.º 60079-11	2014
Atmosferas explosivas - Parte 7: Proteção do equipamento por maior segurança "e"	CAN/CSA-C22.2 N.º 60079-7	2018

Título	Número	Data de emissão
Atmosferas explosivas - Parte 31: Proteção contra ignição de poeira do equipamento pelo invólucro "I"	CAN/CSA-C22.2 N.º 60079-31	2015
Requisitos de segurança para equipamentos elétricos para medição, controle e uso em laboratório – Parte 1: Requerimentos gerais	CSA C22.2 N.º 61010-1	2012
Graus de proteção fornecidos por gabinetes (código IP)	CSA C22.2 No. 60529	2016

### Padrões IECEx

Título	Número	Data de emissão
Atmosferas explosivas - Parte 0: Equipamento - Requisitos gerais	IEC 60079-0	2017
Atmosferas explosivas - Parte 11: Proteção do equipamento por segurança intrínseca "i"	IEC 60079-11	2011
Atmosferas explosivas - Parte 7: Proteção do equipamento por maior segurança "e"	IEC 60079-7	2017
Atmosferas explosivas - Parte 31: Proteção contra ignição de poeira do equipamento pelo invólucro "I"	IEC 60079-31	2013
Graus de proteção fornecidos por gabinetes (código IP)	IEC 60529	2013

### Padrões ATEX

Título	Número	Data de emissão
Atmosferas explosivas - Parte 0: Equipamento - Requisitos gerais	EN IEC 60079-0	2018
Atmosferas explosivas - Parte 11: Proteção do equipamento por segurança intrínseca "i"	EN 60079-11	2012
Atmosferas explosivas - Parte 7: Proteção do equipamento por maior segurança "e"	EN 60079-7	2015 +A1:2018
Atmosferas explosivas - Parte 31: Proteção contra ignição de poeira do equipamento pelo invólucro "I"	EN 60079-31	2014
Graus de proteção fornecidos por gabinetes (código IP)	EN 60529	1991 + A1:2000 + A2:2013

### Padrões UKEX

Título	Número	Data de emissão
Atmosferas explosivas - Parte 0: Equipamento - Requisitos gerais	EN IEC 60079-0	2018
Atmosferas explosivas - Parte 11: Proteção do equipamento por segurança intrínseca "i"	EN 60079-11	2012
Atmosferas explosivas - Parte 7: Proteção do equipamento por maior segurança "e"	EN 60079-7	2015 +A1:2018
Atmosferas explosivas - Parte 31: Proteção contra ignição de poeira do equipamento pelo invólucro "I"	EN 60079-31	2014
Graus de proteção fornecidos por gabinetes (código IP)	EN 60529	1991 + A1:2000 + A2:2013

## 6.4 Dimensões

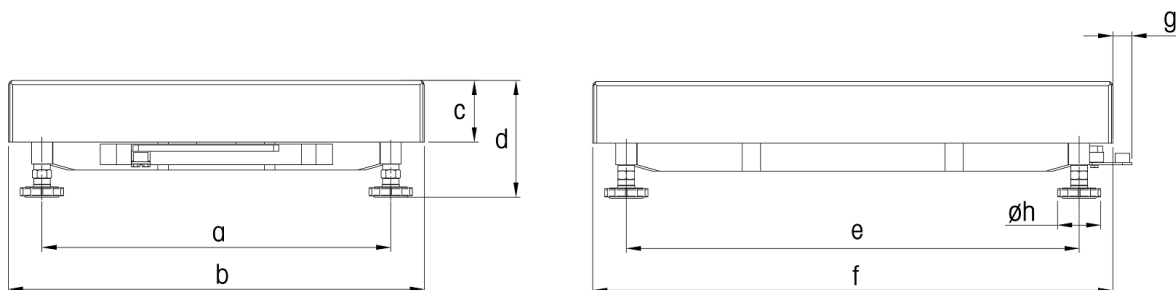

Dimensões		a	b	c	d *	e	f	g	h
PBA439(x/xx)-QA	mm	163	228	56	85,6	163	228	21	42
	polegadas	6,42	8,98	2,20	3,37	6,42	8,98	0,83	1,65
PBA439(x/xx)-A	mm	175	240	56	85,6	235	300	21	42
	polegadas	6,89	9,45	2,20	3,37	9,25	11,81	0,83	1,65
PBA439(x/xx)-QB	mm	240	305	57	96,6	253	305	18	42
	polegadas	9,45	12,01	2,24	3,8	9,96	12,01	0,71	1,65
PBA439(x/xx)-BB	mm	235	300	57	96,6	335	400	18	42
	polegadas	9,25	11,81	2,24	3,8	13,19	15,75	0,71	1,65
PBA439(x/xx)-B	mm	335	400	59	100,1	435	500	18	42
	polegadas	13,19	15,75	2,32	3,94	17,13	19,69	0,71	1,65
PBA439(x/xx)-BC	mm	437	500	73	106,8	584	650	17	42
	polegadas	17,20	19,69	2,87	4,2	22,99	25,59	0,67	1,65
PBA439(x/xx)-CC	mm	503	600	85	128,3	724	800	18	42
	polegadas	19,80	23,62	3,35	5,05	28,5	31,50	0,71	1,65

\* : 1) d = altura mínima da plataforma. Com os pés de escala ajustáveis, a altura da plataforma pode aumentar em 10 mm / 0,39 pol no máximo.

2) Com a opção de kit de higiene, a altura da plataforma mínima (d) aumenta em 12 mm / 0,47 pol.

## 6.5 Informações sobre pré-carga de capacidade

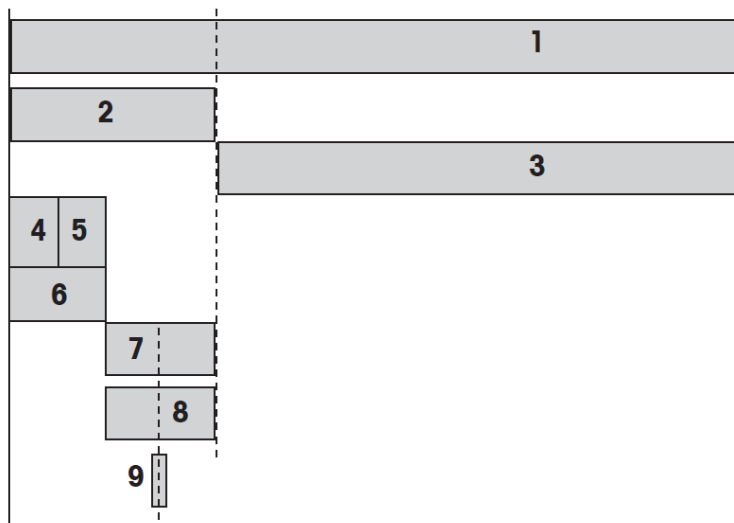

<b>1</b>	Faixa de carga máxima da célula de carga ( $E_{max}$ )
<b>2</b>	Pré-carga máxima = Faixa de carga máxima <b>1</b> – Carga máxima <b>3</b>
<b>3</b>	Carga máxima = Faixa de carga máxima <b>1</b> – Pré-carga máxima <b>2</b>
<b>4</b>	Seção superior de pré-carregamento
<b>5</b>	Prato de pesagem pré-carga
<b>6</b>	Pré-carga ex works = Pré-carga da seção superior <b>4</b> + Prato de pesagem pré-carga <b>5</b>
<b>7</b>	Reserva de pré-carga mecânica = Pré-carga máxima <b>2</b> – Pré-carga ex works <b>6</b>
<b>8</b>	A faixa definida como zero (ligar) pode ser definida. A faixa definida como zero deve estar dentro da pré-carga máxima. A faixa definida como zero pode chegar a um máx. de 18% da carga máxima.
<b>9</b>	Faixa definida como zero $\pm$ 2% da carga máxima

### 6.5.1 Tabela de pré-carga em quilogramas

Tipo	Dimensões [mm]	Máx. carga (3)	Seção sup. de pré-carga (4)	Prato de pesagem pré-carga (5)	Pré-carga ex works (6)	Reserva pré-carga mec. (7)	Faixa definida como zero (8)	Máx. faixa de carga (1)
PBA439(x/xx)-QA3	228x228	3	1,04	0,95	1,99	6,01	0,54	11
PBA439(x/xx)-QA6	228x228	6	1,04	0,95	1,99	3,01	1,08	11
PBA439(x/xx)-A3	240x300	3	1,49	1,23	2,72	5,28	0,54	11
PBA439(x/xx)-A6	240x300	6	1,49	1,23	2,72	2,28	1,08	11
PBA439(x/xx)-A15	240x300	15	1,49	1,23	2,72	4,28	2,70	22
PBA439(x/xx)-QB15	305x305	15	1,70	1,51	3,21	3,79	2,70	22
PBA439(x/xx)-QB30	305x305	30	1,70	1,51	3,21	16,79	5,40	50
PBA439(x/xx)-QB60	305x305	60	1,70	1,51	3,21	36,79	10,80	100
PBA439(x/xx)-BB30	300x400	30	2,08	1,86	3,94	16,06	5,40	50
PBA439(x/xx)-BB60	300x400	60	2,08	1,86	3,94	36,06	10,80	100
PBA439(x/xx)-B30	400x500	30	3,45	2,85	6,30	13,70	5,40	50
PBA439(x/xx)-B60	400x500	60	3,45	2,85	6,30	33,70	10,80	100
PBA439(x/xx)-B150	400x500	150	3,45	2,85	6,30	43,70	27,00	200
PBA439(x/xx)-BC60	500x650	60	7,00	5,80	12,80	27,20	10,80	100
PBA439(x/xx)-BC150	500x650	150	7,00	5,80	65,00	35,00	27,00	250
PBA439(x/xx)-BC300	500x650	300	7,00	5,80	12,80	187,20	54,00	500
PBA439(x/xx)-CC60	600x800	60	9,36	11,00	20,36	19,64	10,80	100
PBA439(x/xx)-CC150	600x800	150	9,36	11,00	20,36	79,64	27,00	250
PBA439(x/xx)-CC300	600x800	300	9,36	11,00	20,36	179,64	54,00	500
PBA439(x/xx)-CC600	600x800	600	11,50	14,10	25,60	124,40	108,00	750

## 6.5.2 Tabela de pré-carga em libras

Tipo	Dimensões [polegadas]	Máx. carga (3)	Seção sup. de pré-carga (4)	Prato de pesagem pré-carga (5)	Pré-carga ex works (6)	Reserva pré-carga mec. (7)	Faixa definida como zero (8)	Máx. faixa de carga (1)
PBA439(x/xx)-QA6	9x9	10	2,29	2,09	4,39	9,86	1,8	24
PBA439(x/xx)-A6	9,5x11,8	10	3,28	2,71	6,00	8,25	1,8	24
PBA439(x/xx)-A15	9,5x11,8	25	3,28	2,71	6,00	17,51	4,5	49
PBA439(x/xx)-QB15	12x12	25	3,75	3,33	7,08	16,42	4,5	49
PBA439(x/xx)-QB30	12x12	50	3,75	3,33	7,08	53,15	9,0	110
PBA439(x/xx)-QB60	12x12	100	3,75	3,33	7,08	113,39	18,0	220
PBA439(x/xx)-BB30	11,8x15,7	50	4,59	4,10	8,69	51,54	9,0	110
PBA439(x/xx)-BB60	11,8x15,7	100	4,59	4,10	8,69	111,78	18,0	220
PBA439(x/xx)-B30	15,7x19,7	50	7,61	6,28	13,89	46,34	9,0	110
PBA439(x/xx)-B60	15,7x19,7	100	7,61	6,28	13,89	106,57	18,0	220
PBA439(x/xx)-B150	15,7x19,7	250	7,61	6,28	13,89	177,04	45,0	441
PBA439(x/xx)-BC60	19,7x25,6	100	15,43	12,79	28,22	92,24	18,0	220
PBA439(x/xx)-BC150	19,7x25,6	250	15,43	127,87	143,30	157,86	45,0	551
PBA439(x/xx)-BC300	19,7x25,6	500	15,43	12,79	28,22	574,09	90,0	1102
PBA439(x/xx)-CC60	23,6x29,5	100	20,64	24,25	44,89	75,58	18,0	220
PBA439(x/xx)-CC150	23,6x29,5	250	20,64	24,25	44,89	256,27	45,0	551
PBA439(x/xx)-CC300	23,6x29,5	500	20,64	24,25	44,89	557,43	90,0	1102
PBA439(x/xx)-CC600	23,6x29,5	1000	25,35	31,09	56,44	597,03	180,0	1653

## 6.6 Acessórios

### Coluna

Artigo #	Designação	Descrição
72229393	Coluna aberta 120 mm / 4,7"	Adapta-se a todos os tamanhos de plataforma
72198702	Coluna aberta 330 mm / 13"	Adapta-se a todos os tamanhos de plataforma
72198703	Coluna aberta 660 mm / 26"	Adapta-se a todos os tamanhos de plataforma
72198704	Coluna aberta 900 mm / 35,4"	Adapta-se a todos os tamanhos de plataforma maiores que o tamanho A

### Carrinho de aço inoxidável

Artigo #	Designação	Descrição
72225939	Carrinho de aço inoxidável BC	Adapta-se para plataforma de tamanho BC
72225940	Carrinho de aço inoxidável CC	Adapta-se para plataforma de tamanho CC

### Trilho de roletes

Artigo #	Designação	Descrição
30253326	Trilho de roletes 400 x 500 mm / 15,7" x 19,7" aço inoxidável	Adapta-se para plataforma de tamanho B. Rolo para o lado mais curto da plataforma
30253328	Trilho de roletes 500 x 650 mm / 19,7" x 25,6" aço inoxidável	Adapta-se para plataforma de tamanho BC. Rolo para o lado mais curto da plataforma
30253330	Trilho de roletes 600 x 800 mm / 23,6" x 31,5" aço inoxidável	Adapta-se para plataforma de tamanho CC. Rolo para o lado mais curto da plataforma
30253327	Trilho de roletes 400 x 500 mm / 15,7" x 19,7" aço inoxidável	Adapta-se para plataforma de tamanho B. Rolo para o lado longo da plataforma
30253329	Trilho de roletes 500 x 650 mm / 19,7" x 25,6" aço inoxidável	Adapta-se para plataforma de tamanho BC. Rolo para o lado longo da plataforma
30253331	Trilho de roletes 600 x 800 mm / 23,6" x 31,5" aço inoxidável	Adapta-se para plataforma de tamanho CC. Rolo para o lado longo da plataforma
30640393	Trilho de roletes 400 x 500 mm / 15,7" x 19,7" aço inoxidável	Adapta-se para área perigosa
30640394	Trilho de roletes 500 x 650 mm / 19,7" x 25,6" aço inoxidável	Adapta-se para área perigosa
30640395	Trilho de roletes 600 x 800 mm / 23,6" x 31,5" aço inoxidável	Adapta-se para área perigosa

### Suporte de montagem frontal

Artigo #	Designação	Descrição
22021062	Suporte de montagem frontal	Adequado para montagem frontal ICS4_9

### Prato de aço inoxidável

Artigo #	Designação	Descrição
30676769	Prato de aço inoxidável AISI 316 240 x 300 mm / 9,5" x 11,8"	Adapta-se para plataforma de tamanho A
30676770	Prato de aço inoxidável AISI 316 300 x 400 mm / 11,8" x 15,7"	Adapta-se para plataforma de tamanho BB
30676771	Prato de aço inoxidável AISI 316 400 x 500 mm / 15,7" x 19,7"	Adapta-se para plataforma de tamanho B.
30676772	Prato de aço inoxidável AISI 316 228 x 228 mm / 9" x 9"	Adapta-se para plataforma de tamanho QA



<b>Artigo #</b>	<b>Designação</b>	<b>Descrição</b>
30676773	Prato de aço inoxidável AISI 316 305 x 305 mm / 12" x 12"	Adapta-se para plataforma de tamanho QB
30676774	Prato de aço inoxidável AISI 316 500 x 650 mm / 19,7" x 25,6"	Adapta-se para plataforma de tamanho BC
30676775	Prato de aço inoxidável AISI 316, espessura 2,0 mm, 600 x 800 mm / 23,6" x 31,5"	Adapta-se para plataforma de tamanho CC
30676776	Prato de aço inoxidável AISI 316, espessura 2,5 mm, 600 x 800 mm / 23,6" x 31,5"	Adapta-se para plataforma de tamanho CC

## 7 Possibilidades de montagem

O PBA439(x/xx) suporta montagem em dispositivo estável. Caso seja necessária perfuração na plataforma de pesagem, siga o padrão de perfuração abaixo.



**NOTA: As áreas de sombra são onde a perfuração na plataforma de pesagem é permitida.**

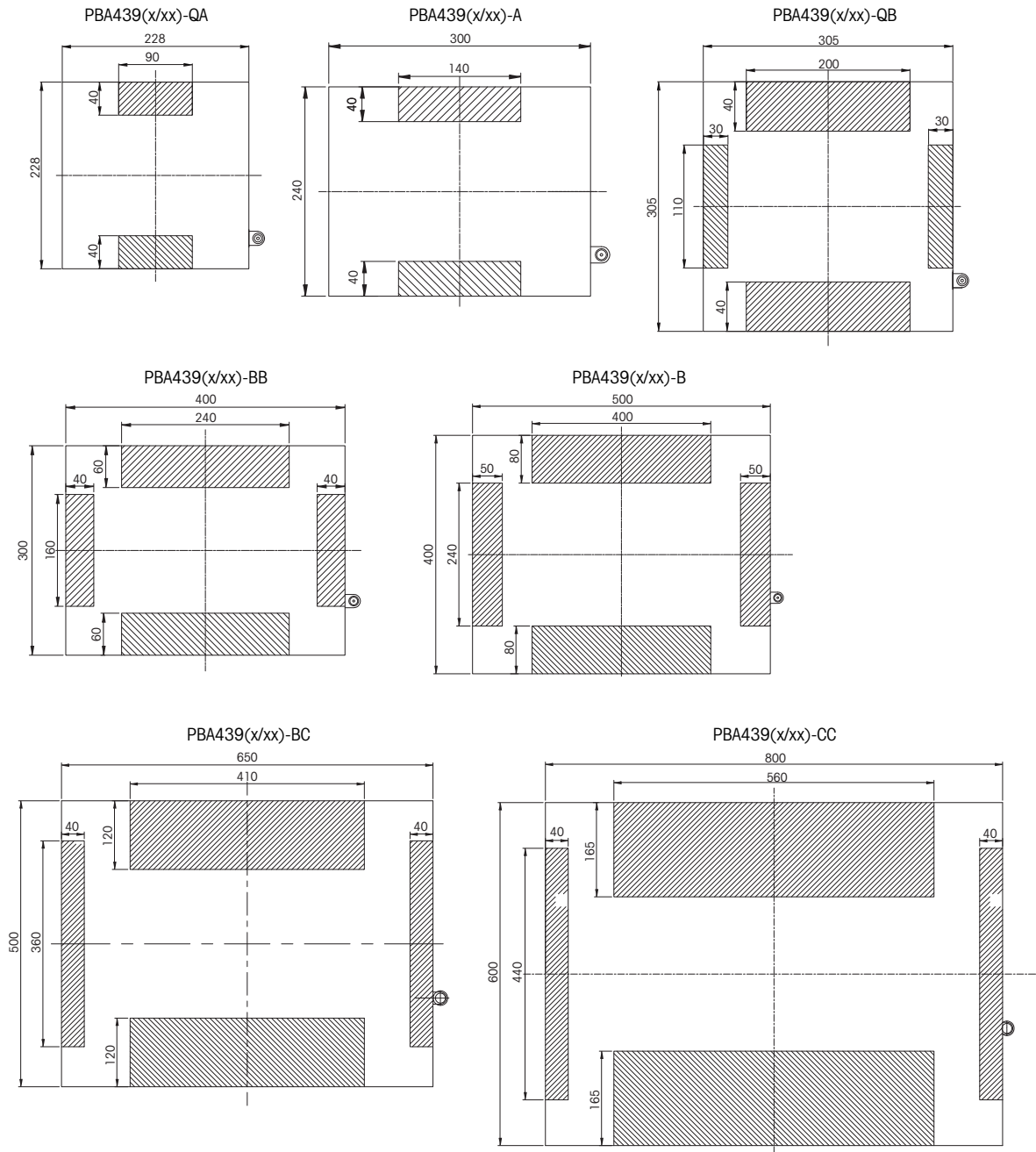

Medido em [mm]



## 8 Apêndice

### 8.1 Etiqueta

<p>IS CL I,II,III DIV 1, GP ABCDEFG T6...T4          Class I, Zone 1, AEx ia IIC T6...T4 Gb          Class II,III, Zone21, AEx ia IIIC T80°C Db          -40°C&lt;Ta&lt;60°C T5/T4; -40°C&lt;Ta&lt;40°C T6          FM21US0076X</p>		<p> II 2G Ex ia IIC T6...T4 Gb          II 2D Ex ia IIIC T80°C Db          -40°C&lt;Ta&lt;60°C T5/T4          -40°C&lt;Ta&lt;40°C T6</p>
-----		
<p>IS CL I,II,III DIV 1, GP ABCDEFG T6...T4          Class I, Zone 1, Ex ia IIC T6...T4 Gb          Class II,III, Zone21, Ex ia IIIC T80°C Db          -40°C&lt;Ta&lt;60°C T5/T4; -40°C&lt;Ta&lt;40°C T6          FM21CA0051X</p>		<p>Entity/NIFW for NonIncendive Field Wiring. Entity parameters are shown in drawing 30688074          Mettler-Toledo GmbH, Im Langacher 44, 8606 Greifensee, Switzerland</p>

<p>NI CL I,II,III DIV 2 GP ABCDEFG T6          -40°C&lt;Ta&lt;60°C          FM21US0076X</p>		<p> II 3G Ex ic IIC T6...T4 Gc          -40°C&lt;Ta&lt;60°C T5/T4          -40°C&lt;Ta&lt;40°C T6</p>
-----		
<p>NI CL I,II,III DIV 2 GP ABCDEFG T6...T4          -40°C&lt;Ta&lt;60°C          Class I, Zone 2, Ex ec IIC T6 Gc;          Class II,III, Zone22, Ex tc IIIC T80°C Dc          FM21CA0051X</p>		<p> II 3G Ex ec IIC T6 Gc U<sub>rated</sub>=20V          II 3D Ex tc IIIC T80°C Dc I<sub>rated</sub>=50mA          -40°C&lt;Ta&lt;60°C</p>
-----		
		<p>Entity/NIFW for NonIncendive Field Wiring. Entity parameters are shown in drawing 30688074          Mettler-Toledo GmbH, Im Langacher 44, 8606 Greifensee, Switzerland</p>

pt



### 8.3 Desenho de instalação

#### Hazardous (Classified) Location

IP67 II 3G Ex ic IIC T6...T4 Gc  
-40°C ≤ T<sub>a</sub> ≤ 60°C T5/T4; -40°C ≤ T<sub>a</sub> ≤ 40°C T6

II 3G Ex ec IIC T6 Gc -40°C ≤ T<sub>a</sub> ≤ 60°C T6  
II 3D Ex tc IIC T80°C Dc  
FM21UKEX0080X  
FM21ATEX0025X IECEx FMG21.0003X

---

II 2G Ex ia IIC T6...T4 Gb  
-40°C ≤ T<sub>a</sub> ≤ 60°C T5/T4; -40°C ≤ T<sub>a</sub> ≤ 40°C T6

II 2D Ex ia IIC T80°C Db  
FM21UKEX0079X  
FM21ATEX0003X IECEx FMG21.0003X

**Approval Mark**

THIS ITEM IS PART OF AGENCY APPROVED PRODUCT

Metrology  
 Safety  
 Ex

DO NOT CHANGE DOCUMENT WITHOUT APPROPRIATE APPROVAL

SLP84x Load Cell

U<sub>i</sub> = 20V  
I<sub>i</sub> = see table 2  
P<sub>i</sub> = see table 2  
C<sub>i</sub> = 6nF  
L<sub>i</sub> = 30uH

Ex Approved Associated Apparatus with Entity Concept Parameters

U<sub>o</sub> ≤ U<sub>i</sub>  
I<sub>o</sub> ≤ I<sub>i</sub>  
P<sub>o</sub> ≤ P<sub>i</sub>  
C<sub>o</sub> ≥ C<sub>c</sub>+C<sub>i</sub>  
L<sub>o</sub> ≥ L<sub>c</sub>+L<sub>i</sub>

Scale structure (attached to load cell) to be connected to system safety ground. See Note.

**NOTES:**

- The resistance between all safety ground connections and the system grounding electrode must not exceed 1ohm.
- Installation shall be in accordance with relevant electrical installation standards (Being shown in Table 1) in hazardous areas (other than mines).
- Entity Parameters C<sub>i</sub> And L<sub>i</sub> Include Maximum Load Cell Cable Length Of 30m
- Entity Parameters C<sub>c</sub> and L<sub>c</sub> is the capacitance and inductance of cable connect between load cell and the associated apparatus.
- In an explosive atmosphere caused by air/dust mixtures, the loose ends of the cable shall be connected outside the hazardous area or in a suitable enclosure with a degree of protection of at least IP6X in accordance with EN 60529.
- For the application of Ex ec, Ex tc: U<sub>rated</sub>=20V, I<sub>rated</sub>=50mA.
- Installation of load cell needs to be done in such way that enclosure welded caps are physically obstructed from any possible impact.
- ⚠ Not following these instructions will jeopardize the explosion safety.
- For the application of Ex ec, The equipment shall only be used in an area of at least pollution degree 2, as defined in IEC 60664-1.

**Table 1**

EN60079-0: 2018	EN60079-14: 2014	EN60079-11: 2012	EN60079-31: 2014
EN61241-14: 2004	EN60079-31: 2013	EN60079-7: 2015	IEC60079-31: 2013
IEC 60079-0-2017	IEC 60079-11-2011	IEC 60079-14-2013	IEC60079-7: 2015

**Table 2**

Temperature class	P <sub>i</sub>	I <sub>i</sub>
T4	2.1W	800mA
T5	1.2W	600mA
T6	0.6W	600mA

Mettler-Toledo GmbH, Im Langacher 44, 8606 Greifensee, Switzerland  
Mettler-Toledo Ltd. 64 Boston Rd. Leicester, LE4 1AW, United Kingdom

D	update drawing status	Wang Jianwen	Liu Yuchun		2021-7-26
C	removed Ex nA of note 6	Wang Jianwen	Liu Yuchun		2021-1-15
REV / CHG	DESCRIPTION	BY	APPVD	AGENCY	E.R. No. DATE
<b>RECORD OF CHANGES</b>					
<b>METTLER TOLEDO</b>		MTCZ	Drawn Wang JW	2020/05/11	Scale 1:1
		CN-213022 ChangZhou	Change		Format mt_A4
Refer to protection notice ISO 16016 / Schutzvermerk ISO 16016 beachten		Note	-		Replaces -
Description 防爆安装图 SLP84X		ERP NO.			ERP Rev
<b>INSTALLATION DRAWING SLP84X ATEX/IECEX</b>		<b>30555321</b>		<b>D</b>	
External Design No.: D000644580		External Design Rev.: D		Status: Approved	Mass: Units: mm 1/1

AutoCAD Mechanical Template V0.2

pt





**To protect your product's future:**  
METTLER TOLEDO Service assures  
the quality, measuring accuracy and  
preservation of value of this product  
for years to come.

Please request full details about our  
attractive terms of service.

[www.mt.com](http://www.mt.com)

For more information

**Mettler-Toledo GmbH**

Im Langacher 44  
8606 Greifensee, Switzerland  
[www.mt.com/contacts](http://www.mt.com/contacts)

Subject to technical changes.  
© 04/2022 METTLER TOLEDO. All rights reserved.  
30704763C

